

# ECKERT

---















GLOBAL







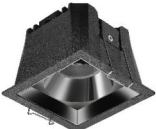











# CONTENTS

## LED DOWNLIGHT

### DOWNLIGHT SERIES







 <p>PAGE 14 <b>LESS SERIES</b> DOUBAL-HEAD TYPE</p>	 <p>PAGE 15 <b>LESS SERIES</b> DOUBAL-HEAD TYPE</p>	 <p>PAGE 16 <b>FRAMELESS SERIES</b></p>
 <p>PAGE 17 <b>HOT-POT SERIES</b> TOW-HEADS TYPE</p>	 <p>PAGE 18 <b>HOT-POT SERIES</b></p>	 <p>PAGE 22 <b>SATURN IP65 SERIES</b></p>
 <p>PAGE 23 <b>DYNAMIC IP65 SERIES</b></p>	 <p>PAGE 24 <b>STAR SERIES</b></p>	 <p>PAGE 25 <b>PISTON SERIES</b></p>
 <p>PAGE 26 <b>JUPITER SERIES</b></p>	 <p>PAGE 27 <b>XB SERIES</b></p>	 <p>PAGE 28 <b>VORTEX SERIES</b></p>
 <p>PAGE 29 <b>MAGIC SERIES</b></p>	 <p>PAGE 31 <b>FLAT SERIES SMD</b></p>	 <p>PAGE 33 <b>SILKY SERIES</b></p>

 <p>PAGE 35 <b>EXCLUSIVE SERIES</b></p>	 <p>PAGE 36 <b>SUNFLOWER SERIES</b></p>	 <p>PAGE 37 <b>BEEHIVE SERIES</b></p>
 <p>PAGE 38 <b>CRYSTAL SERIES</b></p>	 <p>PAGE 39 <b>PAR38-DIAMOND SERIES</b></p>	 <p>PAGE 40 <b>GROW LIGHT PAR38 SERIES</b></p>
 <p>PAGE 41 <b>PAR30-JADE SERIES</b></p>	 <p>PAGE 42 <b>GROW LIGHT PAR30 SERIES</b></p>	 <p>PAGE 43 <b>PAR38 PAR30 HOLDER</b></p>
 <p>PAGE 44 <b>LED STRIPS-APPLICATION REFERENCE</b></p>	 <p>PAGE 45 <b>TINY SERIES-A-SMD</b></p>	 <p>PAGE 46 <b>TINY SERIES-B-COB</b></p>
 <p>PAGE 47 <b>MASTER D IP65 SERIES</b></p>	 <p>PAGE 48 <b>MASTER D IP65 SERIES</b></p>	 <p>PAGE 49 <b>MASTER B SERIES</b></p>
 <p>PAGE 50 <b>SQUARE TWO HEADS TYPE</b></p>	 <p>PAGE 51 <b>MASTER W IP65 SERIES</b></p>	

## LED TRACK LIGHT

 <p>PAGE 54 <b>FAMILY(G2) SERIES</b></p>	 <p>PAGE 56 <b>LEICA ZOOM SERIES</b></p>	 <p>PAGE 58 <b>ELEGANT SERIES</b></p>
 <p>PAGE 59 <b>MUSEUM A SERIES</b></p>	 <p>PAGE 60 <b>MUSEUM B SERIES</b></p>	 <p>PAGE 61 <b>MUSEUM C SERISE</b></p>
 <p>PAGE 62 <b>MUSEUM D SERISE</b></p>	 <p>PAGE 63 <b>LEICA ZOOM S SERIES</b></p>	 <p>PAGE 64 <b>FAMILY S SERIES</b></p>
 <p>PAGE 65 <b>H-TYPE TRACK RAIL AND ACCESSORIES</b></p>	 <p>PAGE 66 <b>HALO TYPE POWER FEEDER AND CONNECTOR</b></p>	

## MAGNETIC LED TRACK LIGHT

 <p>PAGE 68 <b>FROSTED BASIC SERIES FLOODLIGHT</b></p>	 <p>PAGE 69 <b>ANTI-GLARE SERIES GRILLE LIGHT</b></p>	 <p>PAGE 70 <b>ANTI-GLARE SERIES GRILLE LIGHT</b></p>
 <p>PAGE 71 <b>ANTI-GLARE ROTATED SERIES ADJUSTABLE GRILLE LIGHT</b></p>	 <p>PAGE 72 <b>BOOK SERIES FOLDING GRILLE LIGHT</b></p>	 <p>PAGE 73 <b>FROSTED ROTATED SERIES FLOODLIGHT</b></p>



PAGE 74  
**FROSTED ATMOSPHERE  
SERIES FLOODLIGHT  
WITH BAFFLE PLATE**



PAGE 75  
**MAGNETIC  
PENDANT LIGHT**



PAGE 76  
**MASTER SQUARE SERIES**



PAGE 76  
**HIP-HOP SERIES  
(BEAMANGLE  
ADJUSTABLE)**



PAGE 77  
**CRYSTAL  
CYLINDRICAL  
CHANDELIER**



PAGE 77  
**CRYSTAL CORN  
CHANDELIER**



PAGE 77  
**WATER DROP  
CHANDELIER**



PAGE 78  
**RYSTAL SPHERICAL  
CHANDELIER**



PAGE 79  
**LEICA ZOOM M  
SERIES SPOT LIGHT**



PAGE 80  
**FAMILY M SERIES  
SPOT LIGHT**



PAGE 81  
**MUSEUM M SERIES-  
SPOT LIGHT**



PAGE 82  
**EXTERNAL DRIVER  
(OUTER DRIVER)**



PAGE 83  
**INTERNAL DRIVER  
(INTEGRATED  
TRANSFER)**



PAGE 84  
**MAGNETIC TRACK  
RAIL, POWER SUPPLY  
AND ACCESSORIES**

PAGE 87  
**THE COMPOSITION  
OF A SET OF LAMPS**

ETL LIST PRODUCTS FOR NORTH  
AMERICA MARKET

# DOWNLIGHT SERIES



## Modular design

tools-free installation and maintenance  
and other details

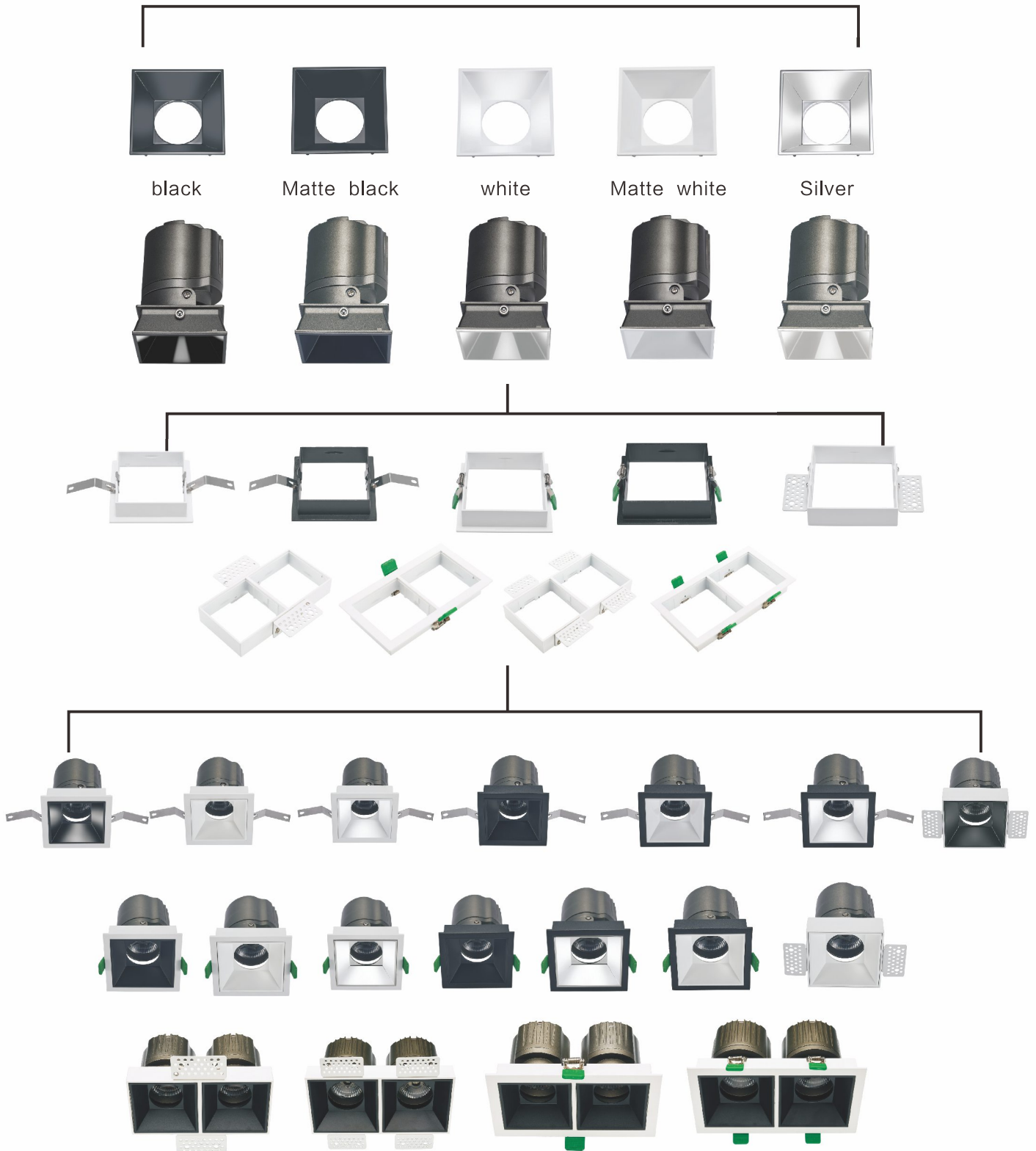

# Modular design



## Modular design

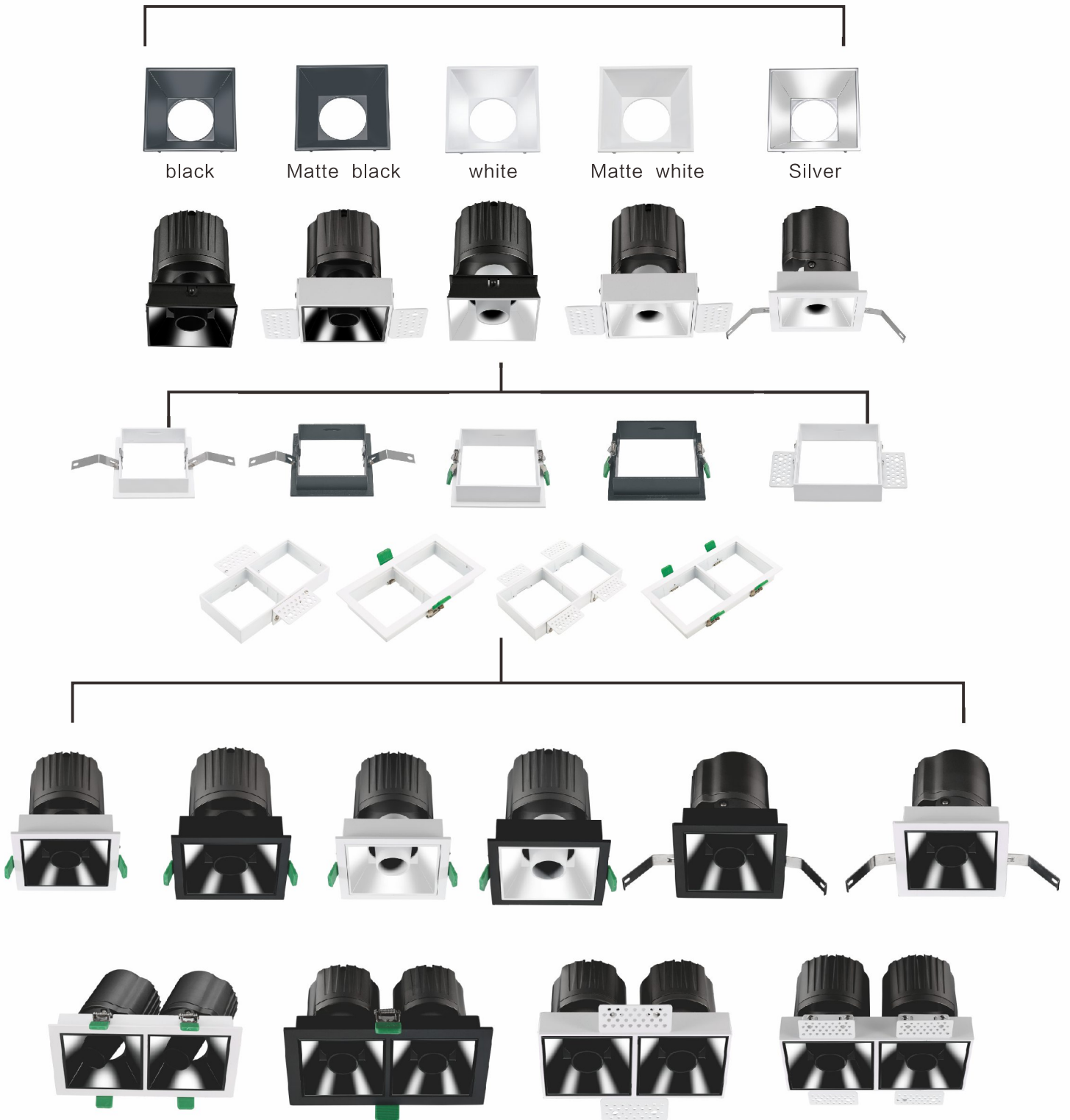

## Modular design

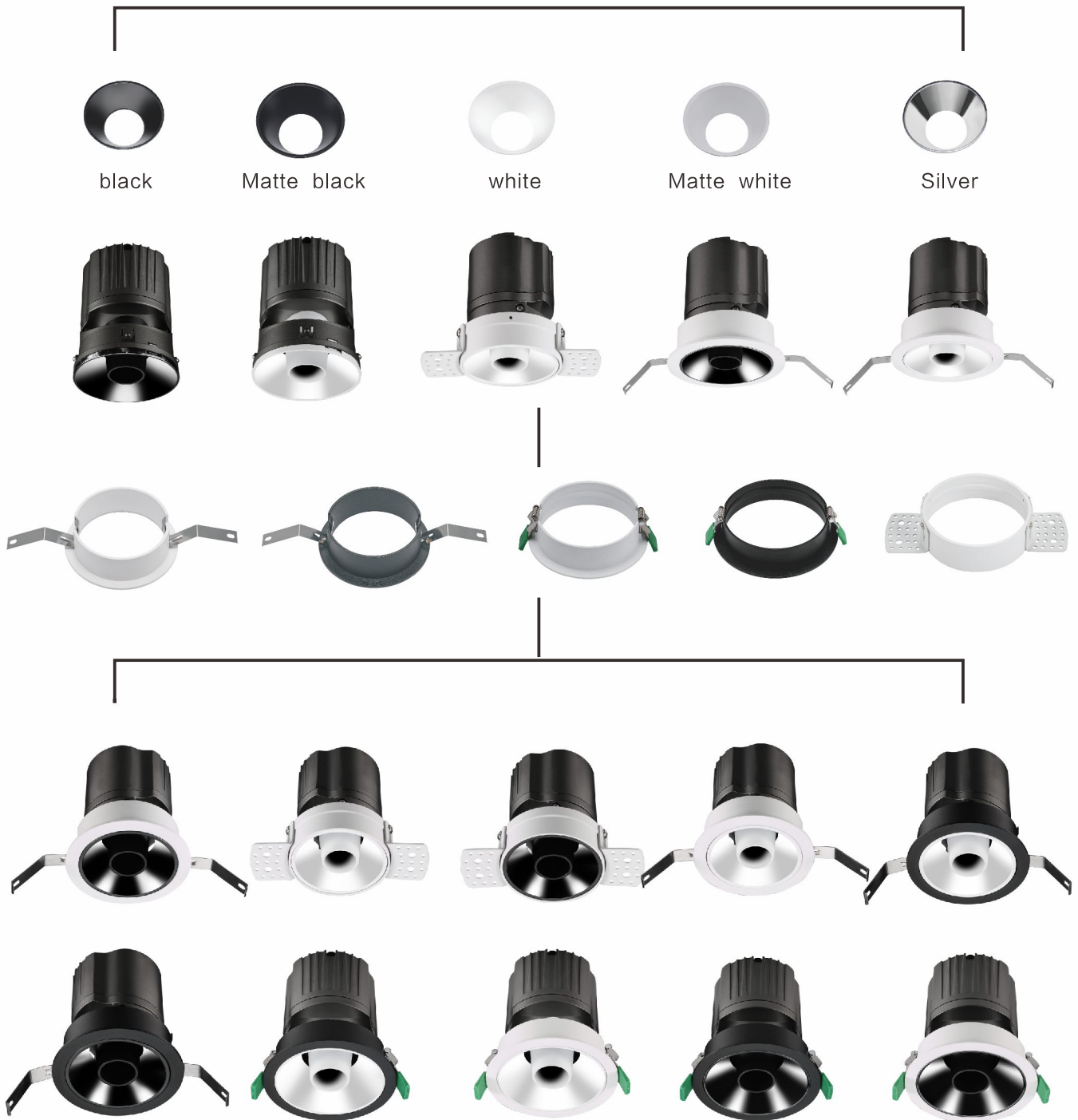



Reflector color options

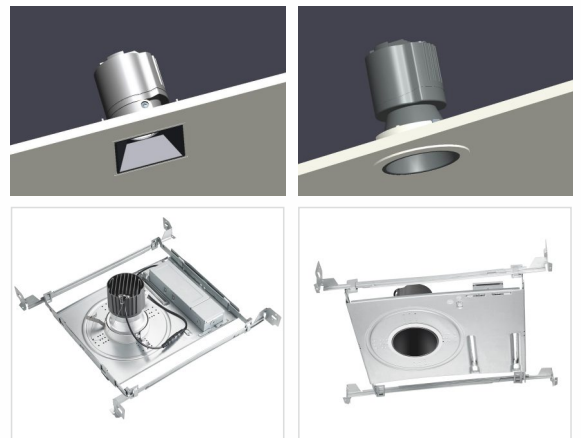

# LESS SERIES

Hot selling model



“Less Series” means less glare”, the darklight technology reflector is the biggest advantage, together with Lens structure.

Total Power:8-12W/15-20W/25-30W/35W/50W (different sizes),

input 100-277V AC

On-off/triac/0-10V/Dali dimming available

Beam angle 15D/24D/36D/60D,CRI90/CRI97,UGR<11

Round & square shape available, swiveling type

5 years warranty, ETL certification

Application:hotel, guesting room, club, villa, residential area, balcony(IP44)



## Round & square frame shape size

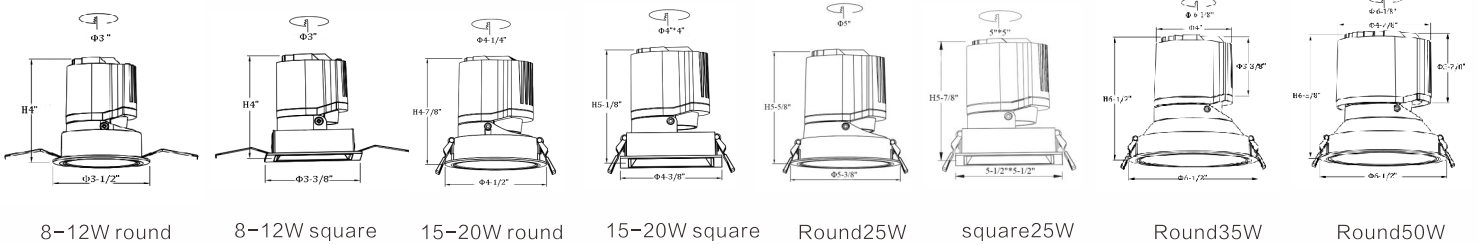

# LESS SERIES DOUBAL-HEAD TYPE

Less series dual-head LED downlight, "Dark light" technology, Lens structure.

**Power:**20W/40W/60W (different sizes), **input:**100-277V AC

On-off/triac/0-10V/Dali dimming available

Beam angle 15D/24D/36D/60D, CRI90/CRI97, UGR<11,

Rectangular shape, Swiveling type

**Housing color:** White or Black frame

**Reflector color:** Black/White/Silver/Matte black/

Matte white 5 years warranty

**Application:**guest room,corridor, restaurant, meeting room,hall,hotel entrance



## Application reference

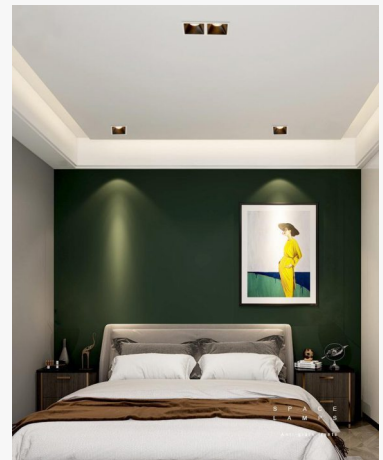

## Less series dual-head type -Product size

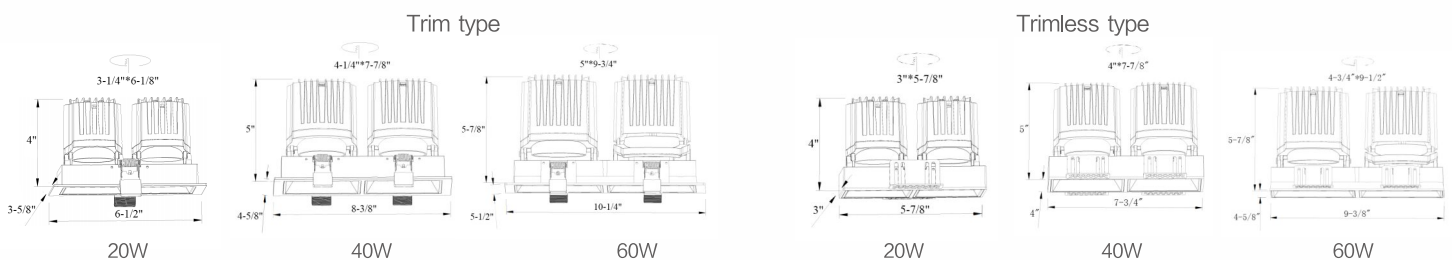

# FRAMELESS SERIES



"Darklight Technology" design but trimless type, Lens structure.  
**Total power:** 8-12w/15-20w/25-30w (different size)  
 Input 100-277V AC, on-off/triac/0-10v/Dali dimming available.  
 Beam angle 15D/24D/36D/60D, CRI90/CRI97, **UGR<11.**

Round and square shape options, swiveling type  
 5 years warranty  
**Application:** hotel, guesting room, club, villa,  
 residential area, balcony(IP44)



### Application reference

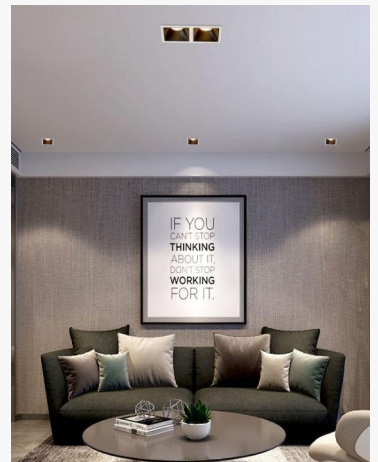

Less frameless Round



Less frameless square



White pinhole type for 3inch only



### Frameless series-Product size

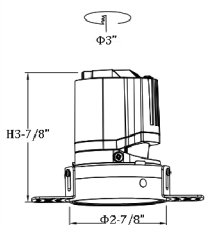

Frameless round  
8-12W

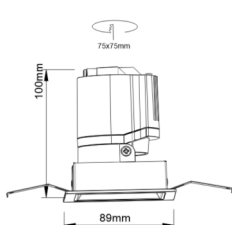

Frameless square  
8-12W

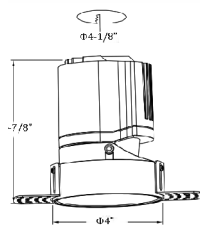

Frameless round  
15-20W

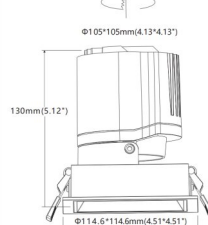

Frameless square  
15-20W

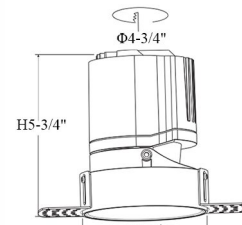

Frameless round  
25-30W

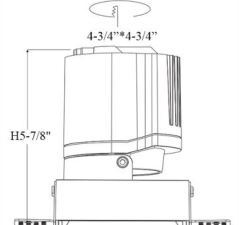

Frameless square  
25-30W

# HOT-POT SERIES TOW-HEADS TYPE

Total Power: 2\*10W(20W in total)/2\*20W(40W in total), input: 100-277V AC

On-off/Triac/0-10V/Dali dimming available

Beam angle 15D/24D/36D/60D, CRI90+, UGR<5

Swiveling type, frameless type optional 5 years warranty,

Application: guest room, corridor, restaurant, meeting room, club, hall, hotel entrance

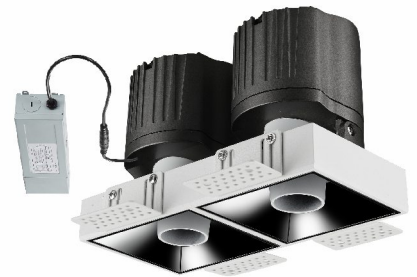
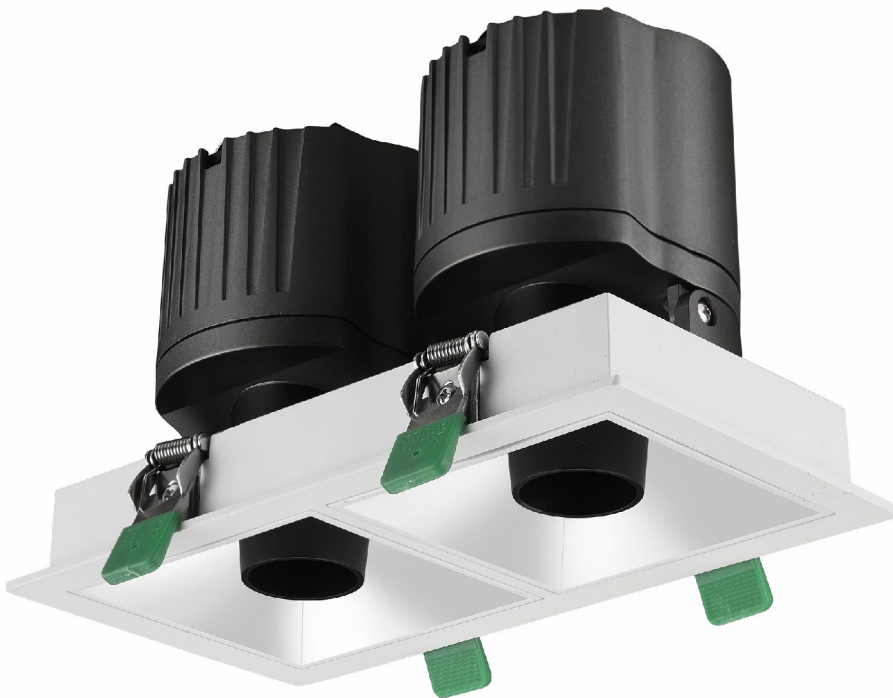

## Application reference

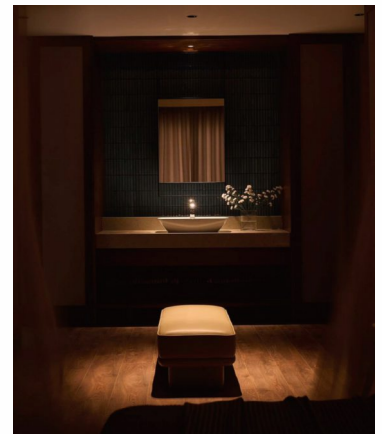

## Product Size

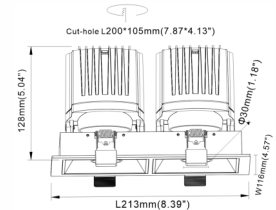
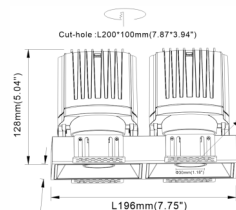
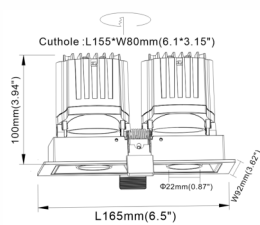
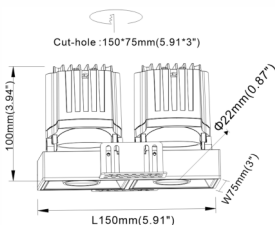

# HOT-POT SERIES



Total Power: 2\*10W(20W in total)/2\*20W(40W in total), input: 100-277V AC

On-off/Triac/0-10V/Dali dimming available

Beam angle 15D/24D/36D/60D, CRI90+, UGR<5

Swiveling type, frameless type optional

5 years warranty,

Application: guest room, corridor, restaurant, meeting room, club, hall, hotel entrance



## Product Size

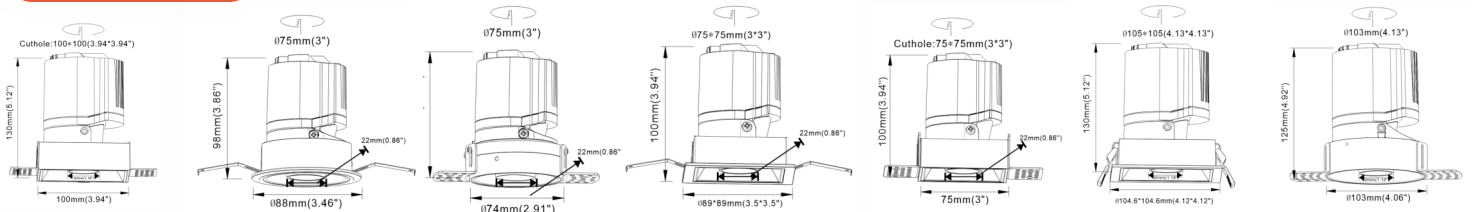



**Round recessed mounted    Square recessed mounted**

Item	Power Supply	Input Voltage	Dimension	Cut-out size	Item	Power Supply	Input Voltage	Dimension	Cut-out size
	8-12W	AC120V/60HZ AC100-277V AC100-348V	Φ88mm*H98mm (3.5")	Φ75-80mm (3.5")		25-30W	AC120V/60HZ AC100-277V AC100-348V	140mm* 140mm* H148mm (5*5")	125*125mm (4.8*4.8")
			86mm*86mm* H100mm (3.5*3.5")	75*75mm (3*3")				30-35W 40-50W	AC120V/60HZ AC100-277V AC100-348V
	15-20W	AC120V/60HZ AC100-277V AC100-348V	Φ115mm*H125mm (4.5")	Φ105mm(4")		20W 2*10W	AC120V/60HZ AC100-277V AC100-348V	L165mm* W92* H100mm	L155mm* W80mm
			110mm*110mm* H130mm (4.5*4.5")	105*105mm (4*4")				40W 2*20W	AC120V/60HZ AC100-277V AC100-348V
	25-30W	AC120V/60HZ AC100-277V AC100-348V	Φ135mm*H145mm (5")	125mm (4.8")		60W 2*30W	AC120V/60HZ AC100-277V AC100-348V	L260mm* W139* H148mm	L245* W125mm

**Trimless round and trimless Square recessed mounted LED downlight**

Item	Mounting type	Power Supply	Input Voltage	Reflector/Beam angle/CCT	Dimension	Cut-out size
	Trimless round recessed mounted	8-12W	AC120V/60HZ AC100-277V AC100-348V	Reflector: Glossy black/ Glossy white/silver Matte black/ Matte white Beam angle: 15° /24° /36° /60° CCT 2700K-6000K/3CCT/ 5CCT change options	Φ75*H98mm(3")	Φ70-75mm (3")
	Trimless square recessed mounted				75mm*75mm* H100mm(3*3")	70*70mm (3*3")
	Trimless round recessed mounted	15-20W	AC120V/60HZ AC100-277V AC100-348V	Reflector: Glossy black/ Glossy white/silver Matte black/ Matte white Beam angle: 15° /24° /36° /60° CCT 2700K-6000K/3CCT/ 5CCT change options	Φ100mm*H125mm (4.5")	Φ100mm(4")
	Trimless square recessed mounted				100mm*100mm* H130mm (4.5*4.5")	100*100mm (4*4")
	Trimless round recessed mounted	25-30W	AC120V/60HZ AC100-277V AC100-348V	Reflector: Glossy black/ Glossy white/silver Matte black/ Matte white Beam angle: 15° /24° /36° /60° CCT 2700K-6000K/3CCT/ 5CCT change options	Φ119mm*H145mm (5")	120mm (4.8")
	Trimless square recessed mounted				120mm*120mm* H148mm (5*5")	120*120mm (4.6*4.6")
	Trimless square two-heads recessed mounted	20W 2*10W	AC120V/60HZ AC100-277V AC100-348V	Reflector: Glossy black/ Glossy white/silver Matte black/ Matte white Beam angle: 15° /24° /36° /60° CCT 2700K-6000K/3CCT/ 5CCT change options	L150mm*W75* H100mm	L150mm* W70mm
	Trimless square two-heads recessed mounted	40W 2*20W	AC120V/60HZ AC100-277V AC100-348V	Reflector: Glossy black/ Glossy white/silver Matte black/ Matte white Beam angle: 15° /24° /36° /60° CCT 2700K-6000K/3CCT/ 5CCT change options	L196mm*W100* H128mm	L200mm* W100mm
	Trimless square two-heads recessed mounted	60W 2*30W	AC120V/60HZ AC100-277V AC100-348V	Reflector: Glossy black/ Glossy white/silver Matte black/ Matte white Beam angle: 15° /24° /36° /60° CCT 2700K-6000K/3CCT/ 5CCT change options	L239mm*W118* H148mm	L239* W120mm

**Pinhole design round and trimless Square recessed mounted LED downlight**

Item	Mounting type	Power Supply	Input Voltage	Reflector/Beam angle/CCT	Dimension	Cut-out size
	Round recessed mounted	8-12W	AC120V /220V / AC100-277V 50/60Hz	Reflector: Glossy black/ Glossy white/silver Matte black/ Matte white Beam angle: 15° /24° /36° /60° CCT 2700K-6000K/3CCT/ 5CCT change options	Φ88mm*H98mm (3.5inch)	Φ75-80MM
	Trimless round recessed mounted				75mm*75mm* H100mm(3*3")	Φ70-75MM
	Square recessed mounted	8-12W	AC120V /220V / AC100-277V 50/60Hz	Reflector: Glossy black/ Glossy white/silver Matte black/ Matte white Beam angle: 15° /24° /36° /60° CCT 2700K-6000K/3CCT/ 5CCT change options	86mm*86mm* H100mm	75-80*75 -80MM
	Trimless Square recessed mounted				75mm*75mm* H100mm	70-75*70 -75MM
	Round recessed mounted	15-20W	AC120V /220V / AC100-277V 50/60Hz	Reflector: Glossy black/ Glossy white/silver Matte black/ Matte white Beam angle: 15° /24° /36° /60° CCT 2700K-6000K/3CCT/ 5CCT change options	Φ115mm*H125mm (4.5inch)	Ø105MM
	Trimless Round recessed mounted				Φ100mm*H125mm (4inch)	Ø105MM
	Square recessed mounted	15-20W	AC120V /220V / AC100-277V 50/60Hz	Reflector: Glossy black/ Glossy white/silver Matte black/ Matte white Beam angle: 15° /24° /36° /60° CCT 2700K-6000K/3CCT/ 5CCT change options	110mm*110mm* H130mm	105*105MM
	Trimless Round recessed mounted				110mm*110mm* H130mm	100*100MM
	Two-heads recessed mounted	20W	AC120V /220V / AC100-277V 50/60Hz	Reflector: Glossy black/ Glossy white/silver Matte black/ Matte white Beam angle: 15° /24° /36° /60° CCT 2700K-6000K/3CCT/ 5CCT change options	L165mm*W92* H100mm	L155*W80 mm
	Trimless Two-heads recessed mounted				L150mm*W75* H100mm	L150*W75 mm
	Two-heads recessed mounted	40W	AC120V /220V / AC100-277V 50/60Hz	Reflector: Glossy black/ Glossy white/silver Matte black/ Matte white Beam angle: 15° /24° /36° /60° CCT 2700K-6000K/3CCT/ 5CCT change options	L213mm*W116* H128mm	L200*W105 mm
	Trimless Two-heads recessed mounted				L196mm*W100* H128mm	L200*W100 mm

# SATURN IP65 SERIES



Saturn IP65 series LED downlight, Reflective cup structure.

**Total Power:** 12W/15W/20W/30W/40W

On-off/triac/0-10V/Dali dimming available

Beam angle 60D, CRI90+, UGR<19, No swiveling type Round & Square available. 5 years warranty,

**Application:** Outdoor corridor, bathroom, eave



## Saturn IP65 series-Product Size

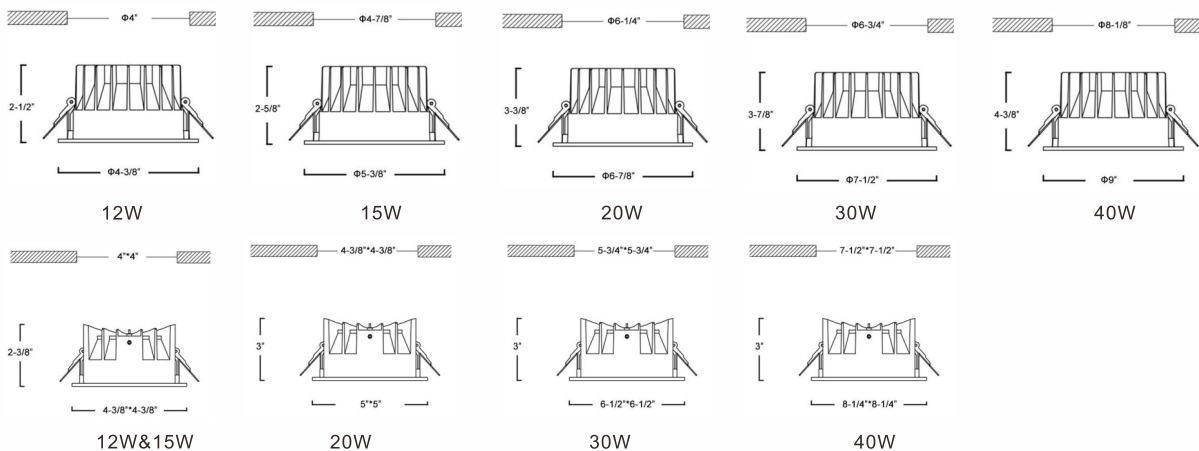

# DYNAMIC IP65 SERIES



Dynamic IP65 series LED downlight, COB Lens structure.

**Power:**12W/20W/30W/40W/50W/60W, **input:**100–277V AC

On–off/triac/0–10V/Dali dimming available

Beam angle 15D/24D/36D/60D,CRI90+,UGR<16,No swiveling type

**Housing color option:** White/Black,

**Reflector color option:**Black/White/Silver 5 years warranty,

**Application:**Outdoor corridor, bathroom,eave



## Dynamic IP65 series–Size

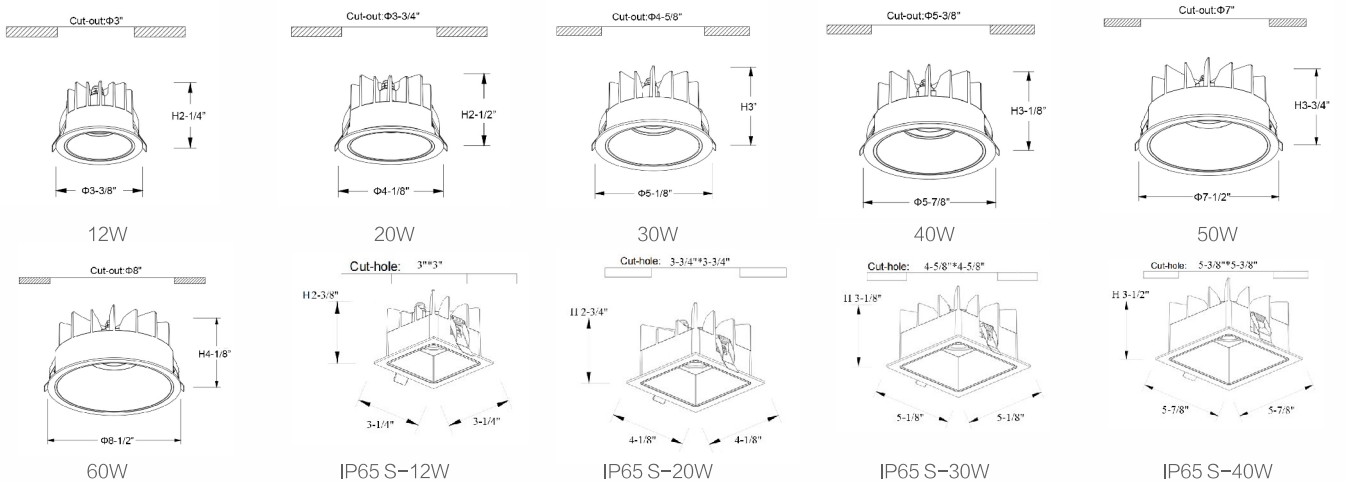

# STAR SERIES



Star Series LED downlight, Lens structure.

**Total Power:** 12W/20W/30W/55W,

**input:** 100–277V AC On–off/triac/0–10V/Dali dimming available

Beam angle 15D/24D/36D, CRI90+, UGR<19

Round/Square/Twins type available, Swiveling type, 360° rotatable

White housing, Black/White inner ring 5 years warranty,

**Application:** guest room, corridor, restaurant, meeting room, club, hall, hotel entrance



## Star series–Twins Size

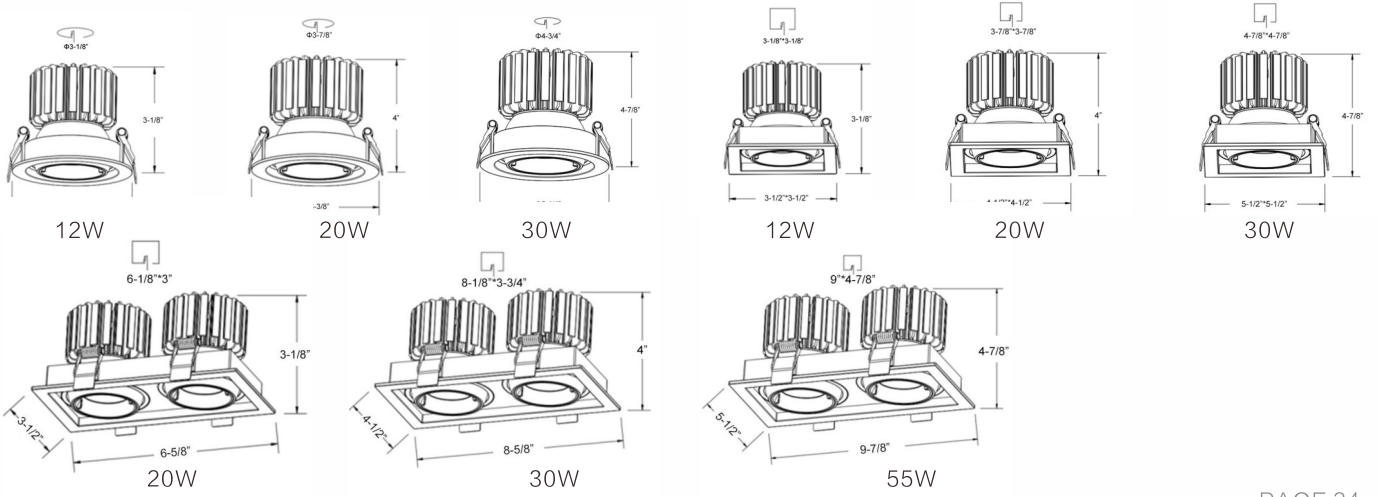

# PISTON SERIES



Could be use as LED downlight & LED track light at the same time.  
 Lens structure as standard product, but reflector structure option have.  
**Power:**12W/15W/20W/30W/15W\*2/20W\*2,**input:**100–277V AC  
 On-off/triac/0–10V/Dali dimming available

Beam angle 15D/24D/38D,Ra>90,UGR<19  
 Round/Square/Twins type available,Swiveling type,  
 300° rotatable  
 5 years warranty  
**Application:**for the places not easy to install track rail.



## Piston series—Product Size

### Piston Round



12W



15W



20W



30W



Piston Twins 30W

### Piston Square



12W



15W



20W



30W



Piston Twins 40W

# JUPITER SERIES



Jupiter Series LED downlight, Reflective cup structure.  
**Total Power:** 12W/15W/20W/30W/40W/50W/55W,  
**input:** 100–277V AC  
 On-off/triac/0–10V/Dali dimming available  
 Beam angle 15D/30D/45D, CRI90+, UGR<19

**Housing color:** white, Reflector color: white/black  
 Round type, No Swiveling, 5 years warranty, ETL certification  
**Application:** corridor, restaurant, meeting room, hall, hotel  
 entrance, airport.



## Application reference

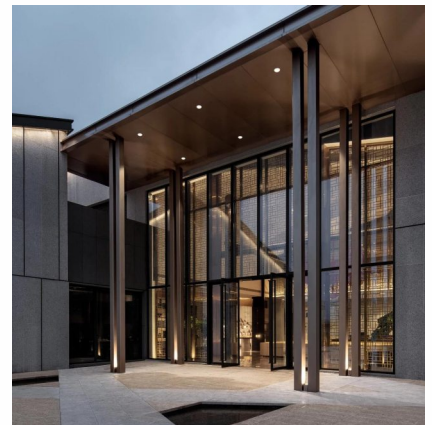

## Jupiter series—Size

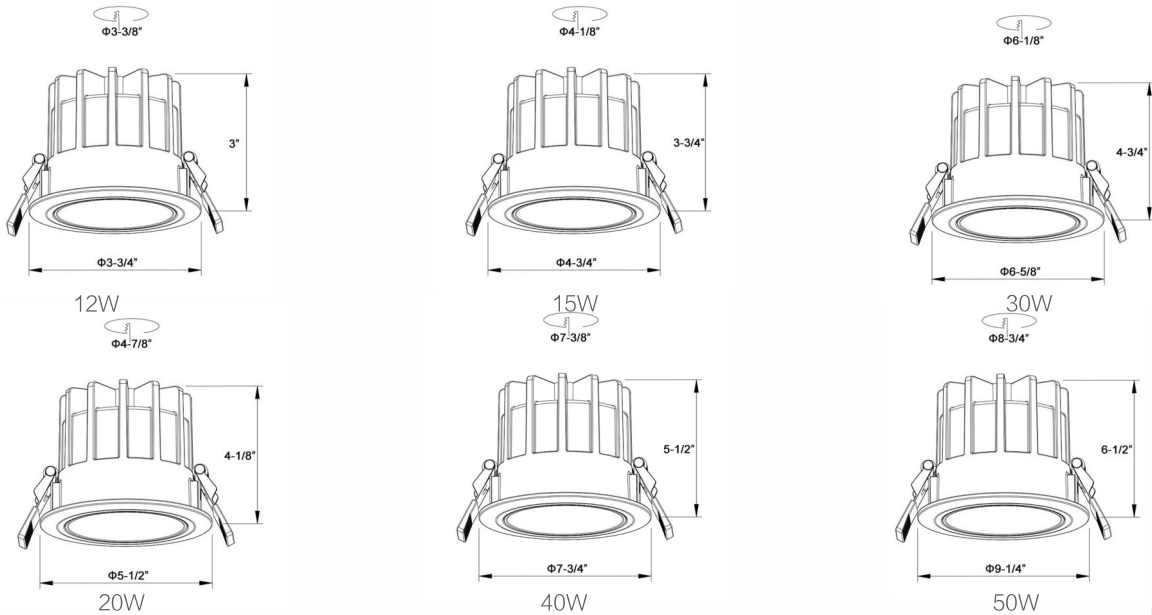

# XB SERIES



XB Series LED downlight Lens structure.  
**Total Power:**8W/15W/25W,  
**input:**100-277V AC  
 On-off/triac/0-10V/Dali dimming available

Beam angle 15D/24D/36D, CRI90+, UGR<19, Swiveling type  
 5 years warranty,  
**Application:**stores,corridor, restaurant,club.



## XB series-Size

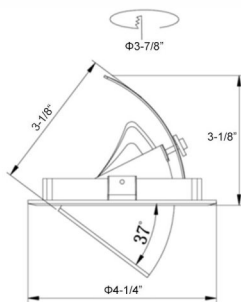

8W

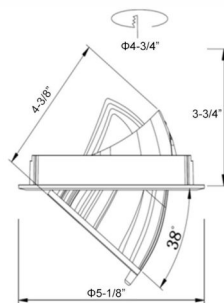

15W

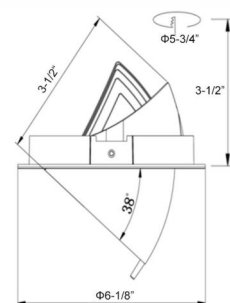

25W

# VORTEX SERIES



Vortex Series LED downlight,

**Total Power:**12W/20W/30W/40W/50W (different sizes),  
**input:**100–277V AC

On–off/triac/0–10V/Dali dimming available  
Beam angle 50D,CRI90+,UGR<19

**Housing color:**White/Black, reflector color: “Dark light” technology reflector  
Round & square shape available, No swiveling type  
5 years warranty,

**Application:**guest room,corridor, restaurant,meeting room,club,hall,  
hotel entrance



## Vortex series–Size

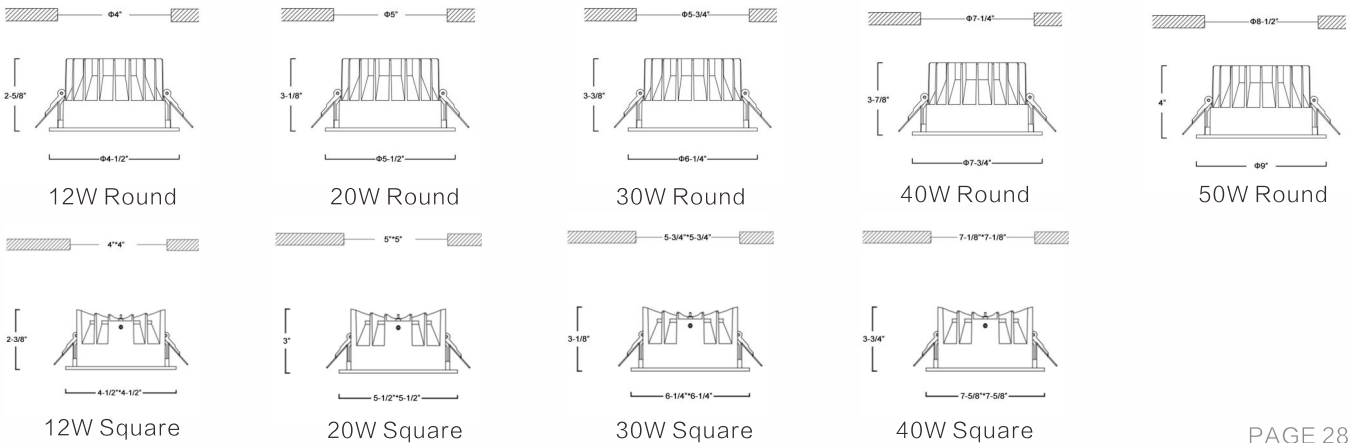

# MAGIC SERIES

Magic series LED downlight, "Dark light" technology, Lens structure.

**Power:** 7W/10W/20W/2\*7W/2\*10W/2\*20W(different sizes),

**input:** 100-277V AC

On-off/triac/0-10V/Dali dimming available

Beam angle 15D/24D/38D,CRI90+,UGR<16



Round and Square shape, No Swiveling type

**Housing color:** White/Black, Reflector color: White/Black

5 years warranty,

**Application:** guest room, corridor, restaurant, meeting room, club

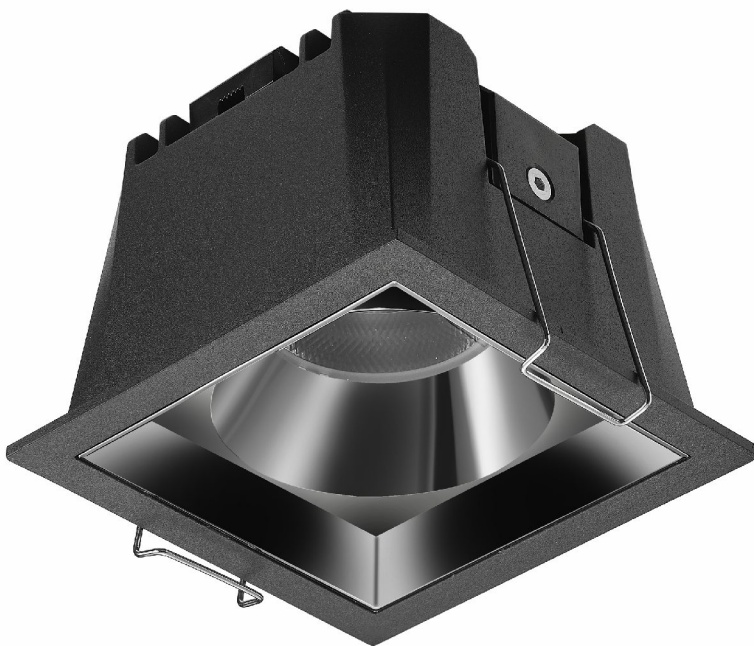

**Magic series—Round & Square Size**

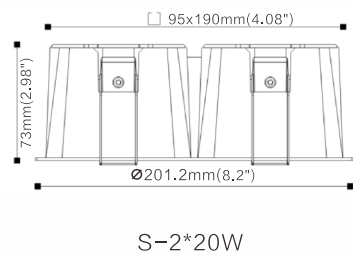
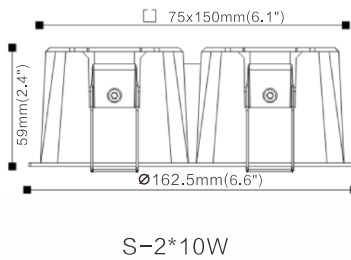
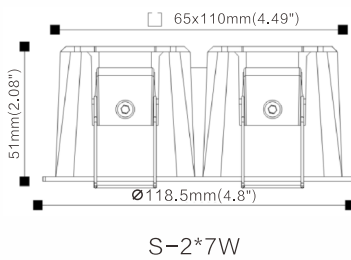
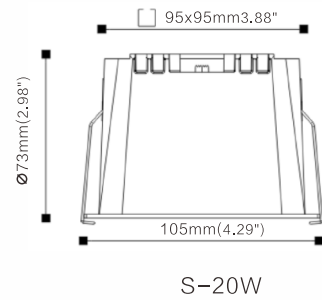
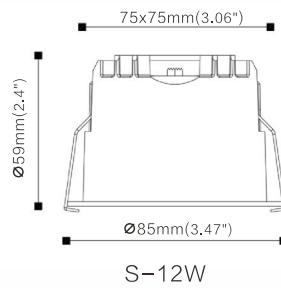
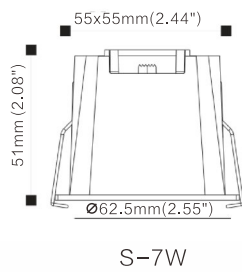
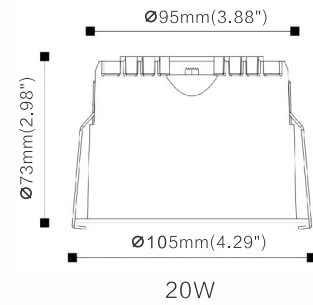
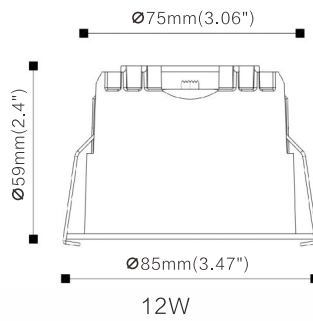
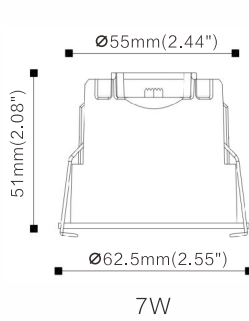

**Application reference**



# FLAT SERIES SMD



Flat series LED downlight, SMD type with wide beam angle 90D.

Power supply: 5W/8W/10W/12W/15W/20W/25W/30W/2\*7W/2\*10W

Input voltage AC100-277V, on-off/Triac dim/0-10v dim/Dali dim available

CCT 2700K/3000K/3500K/4000K/5000K/6000K

Housing color white/black, reflector color black/white/silver/matte black/matte white options.

5 years warranty,

Application: home, club, office, meeting room, hallway

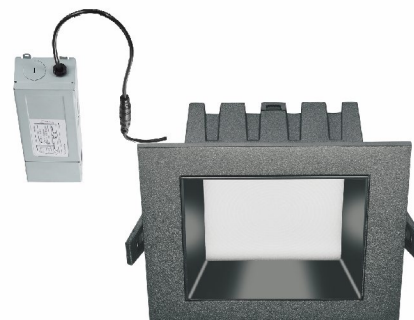

## Application reference



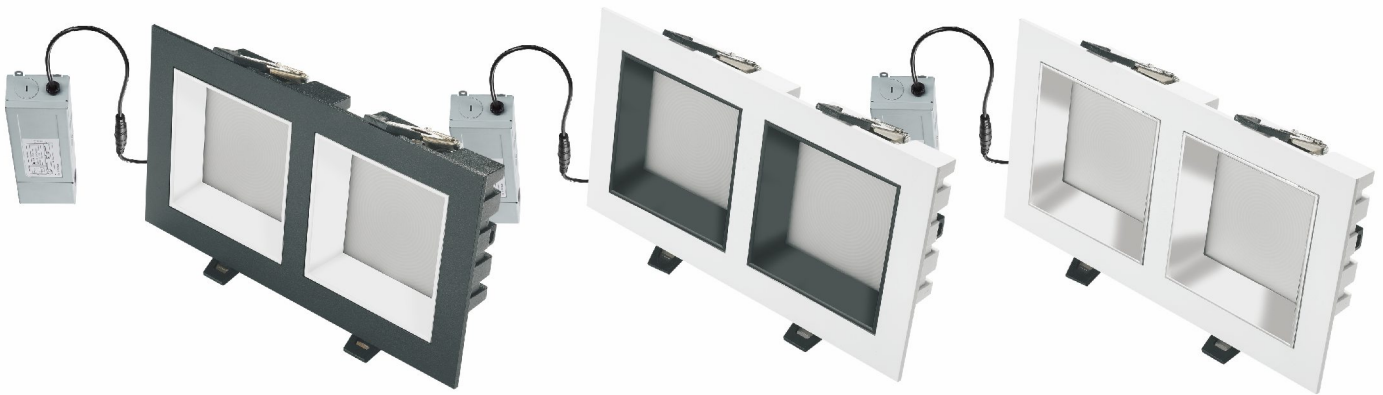

**Flat series—Round & Square Size**

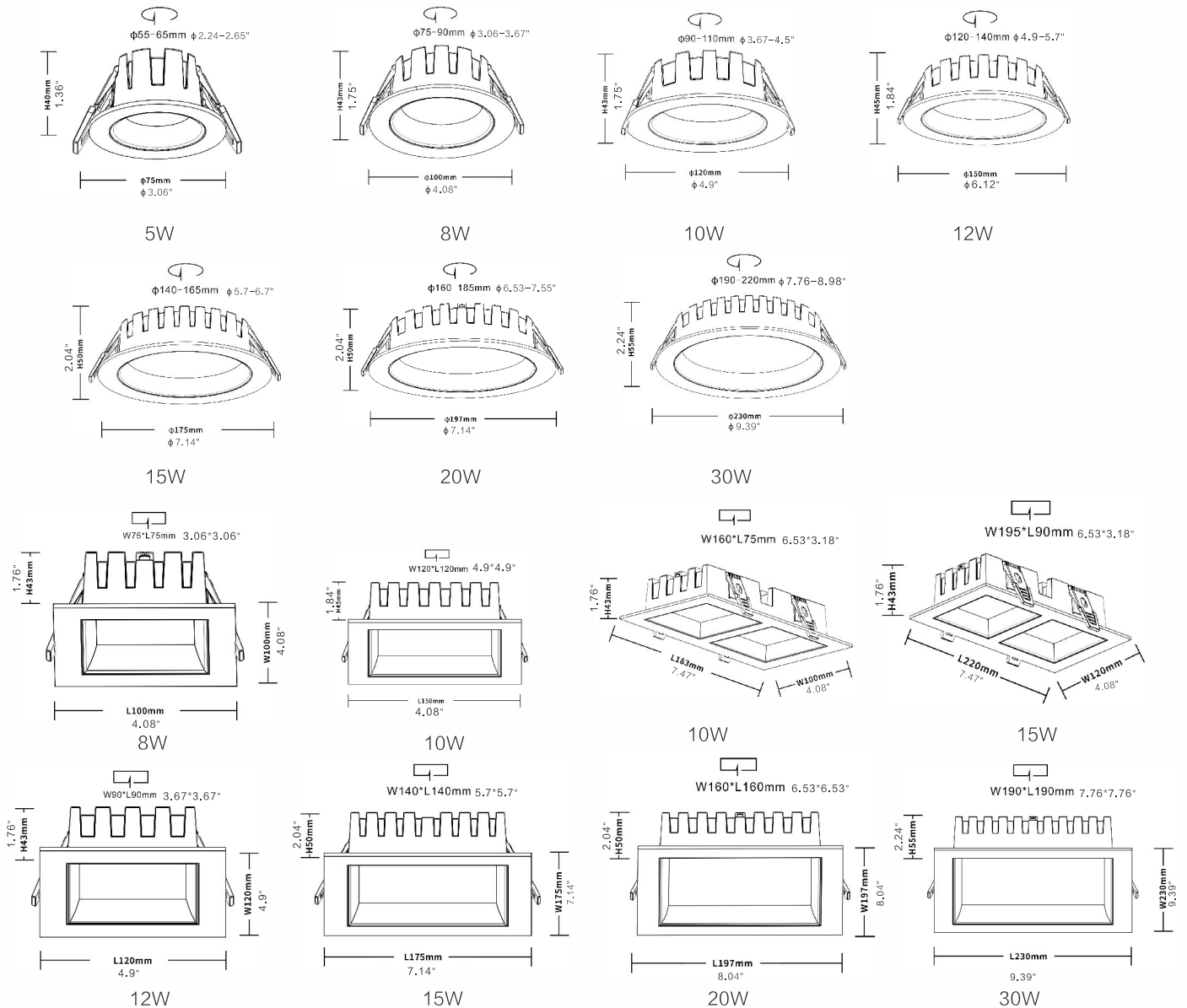

# SILKY SERIES



Silky Series is engineered to support both SMD and COB configuration  
 Power supply 7W/10W/15W/20W/30W/40W in different size  
 Input voltage AC100–277V, on–off/Triac dim/0–10v dim/Dali dim available  
 CCT2700K/3000K/3500K/4000K/5000K, beam angle 15D/24D/36D/60D (COB) 90D(SMD)  
 Black housing color With black/matte black/white/silver/golden reflector.  
 5 years warranty, Application: Living room, home, club, office, meeting room Corridor



## Silky Series–Round & Square Size

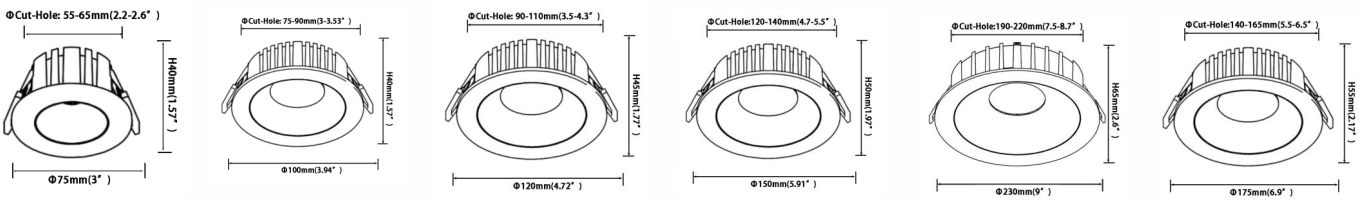



Application reference

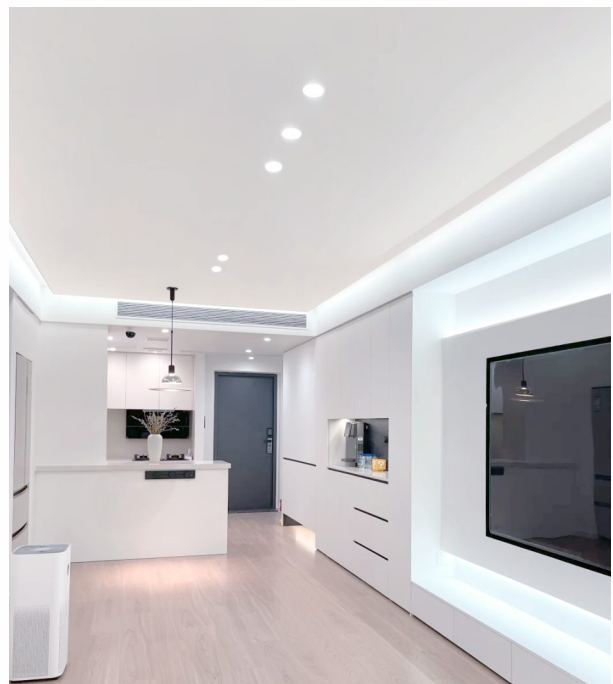

# EXCLUSIVE SERIES



Exclusive series 30W LED spotlight, Lens structure.

White housing, Beam angle 15D/24D/36D/60D

**CCT:**10000K/8000K/6000K/4000K/3000K, Osram chips, Ra>80 or Ra>90

5 years warranty,

**Application:**Jewelry stores



## Exclusive series-Size

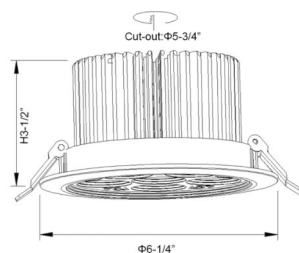

# SUNFLOWER SERIES



RoHS



Sunflower series 40W LED spotlight, Lens structure.

White housing, Beam angle 25D

**CCT:** 10000K/8000K/6000K/4000K/3000K, Osram chips, Ra>80 or Ra>90

5 years warranty,

**Application:** Jewelry stores



Sunflower series s-Size

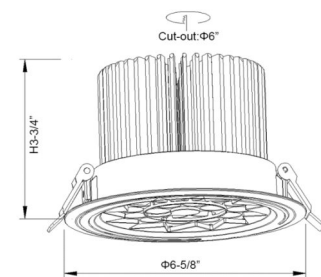

# BEEHIVE SERIES



Beehive series 40W LED spotlight, Lens structure.

White housing, Beam angle 25D

CCT: 10000K/8000K/6000K/4000K/3000K, Osram chips, Ra>80 or Ra>90

5 years warranty,

Application: Jewelry stores



## Beehive series-Size

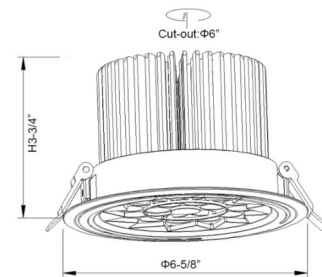

# CRYSTAL SERIES



Crystal series 30W LED spotlight, Lens structive.

White housing, Beam angle 25D/45D

**CCT:** 6000K/5000K/4000K/3500K/3000K, Osram chips, Ra>80 or Ra>90

5 years warranty,

**Application:** Jewelry stores

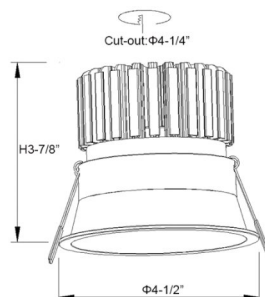

Crystal series-size

# PAR38-DIAMOND SERIES

Diamond series Par38 LED spotlight,7 groups Lens structure

**Option A:** 40W,input:100-277VAC, 40 chips(6\*6+4\*1).

**Option B:** 60W,input:100-277VAC, 42 chips(7\*6).

White/Black housing,Beam angle 15D/25D/45D/80D

**CCT:**10000K/8000K/6000K/4000K/3000K,Osram chips, Ra>80

High quality fan inside of the housing,5 years warranty,

**Application:**Jewelry stores, Church

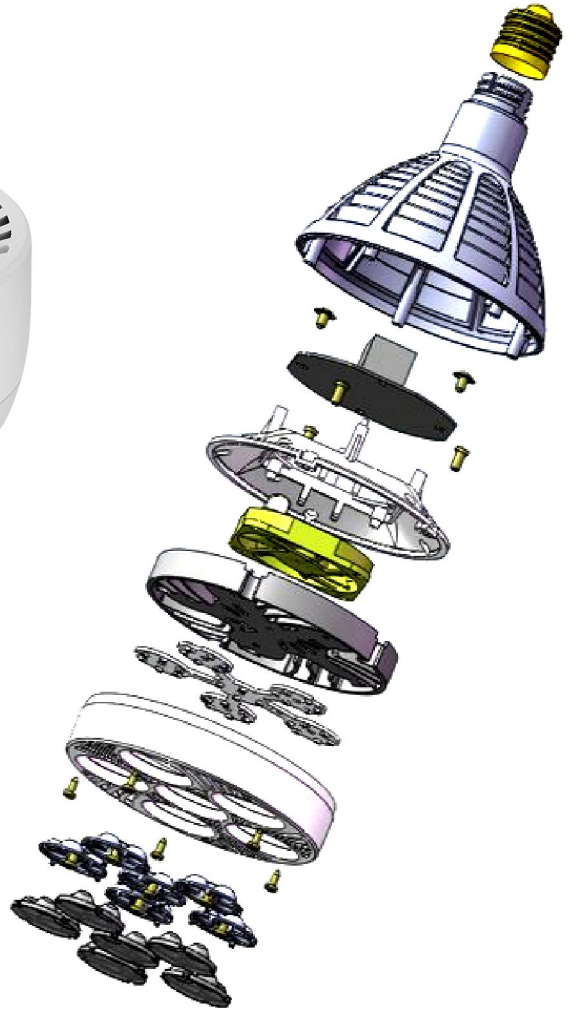

Size & actual picture

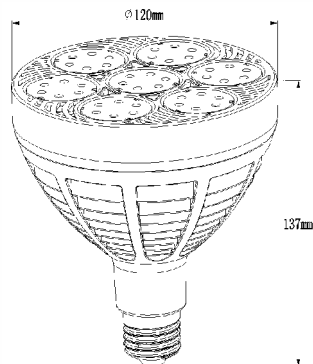

# GROW LIGHT PAR38 SERIES



Grow Light Par38 Series Par38 LED spotlight,7 groups\*4, Lens structive

**Total Power:** 40W/60W,White/Black housing,Beam angle 15D/25D/45D/80D

**CCT:**10000K/8000K/6000K/4000K/3000K/660nm/505nm/450nm/420nm

High quality fan inside of the housing,5 years warranty,

**Application:**plant,aquarium,meat,vegetable



Grow Light Par38 series---current solution for your reference

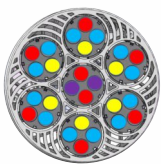

660nm+420nm  
+450nm+3000K

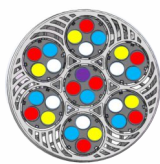

660nm+420nm  
+450nm+3000K  
+6000K

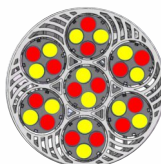

660nm+4500K

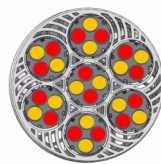

660nm+3000K

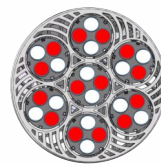

660nm+6000K

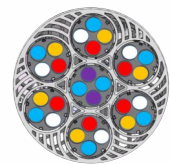

660nm+505nm  
+450nm+3000K  
+6500K

# PAR30-JADE SERIES



Jade series 35W Par30 LED spotlight,Lens structive.  
White/Black housing,Beam angle 15D/25D/45D/80D  
**CCT:**10000K/8000K/6000K/4000K/3000K,Osram chips, Ra>80  
High quality fan inside of the housing,5 years warranty, ETL certification  
**Application:**Jewelry stores

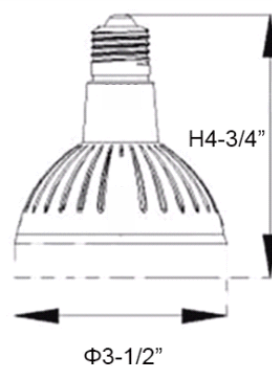

# GROW LIGHT PAR30 SERIES



Grow Light Par30 series LED spotlight,4 groups\*4,Lens structure.

White/Black housing,Beam angle 15D/25D/45D/80D

**CCT:**10000K/8000K/6000K/4000K/3000K/660nm/505nm/450nm/420nm

High quality fan inside of the housing,5 years warranty,

**Application:**plant,aquarium,meat,vegetable

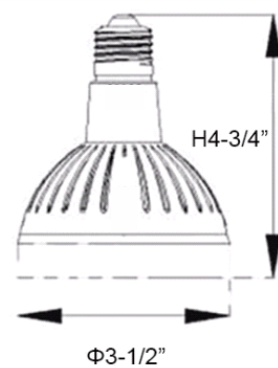

# PAR38 PAR30 HOLDER



RoHS



- H1 and H2 holder
- Suit for Par30 and Par38
- H1 have two sizes, one for Par30, another for Par38.
- H2 just one size, can be used for Par30 or Par38 at the same time.
- White/Black
- Halo(3 wires) or Juno adaptor
- 5 years warranty



H1



H2

# LED Strips – Application reference

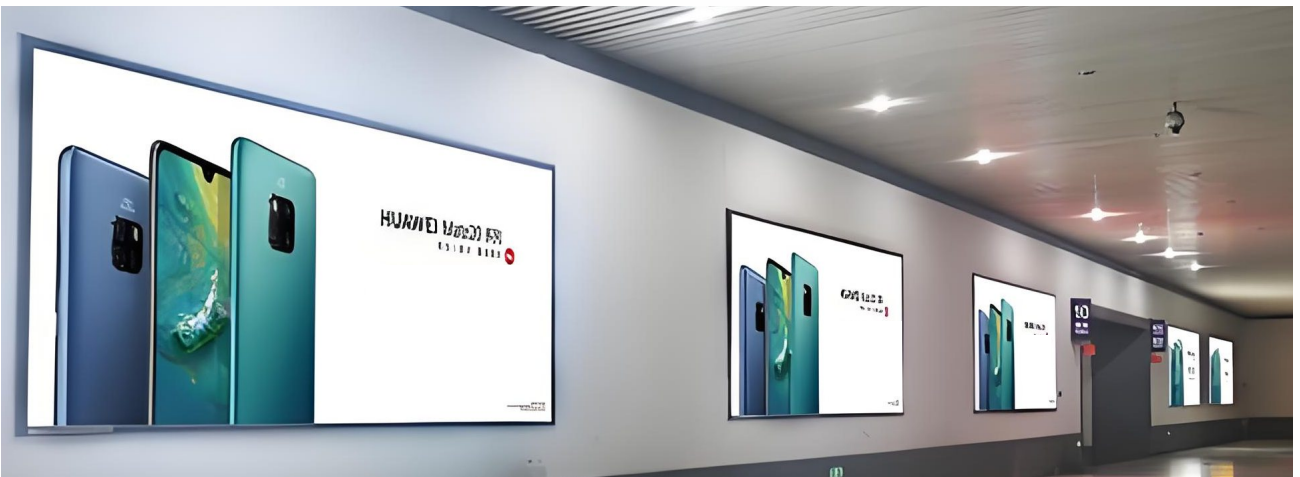
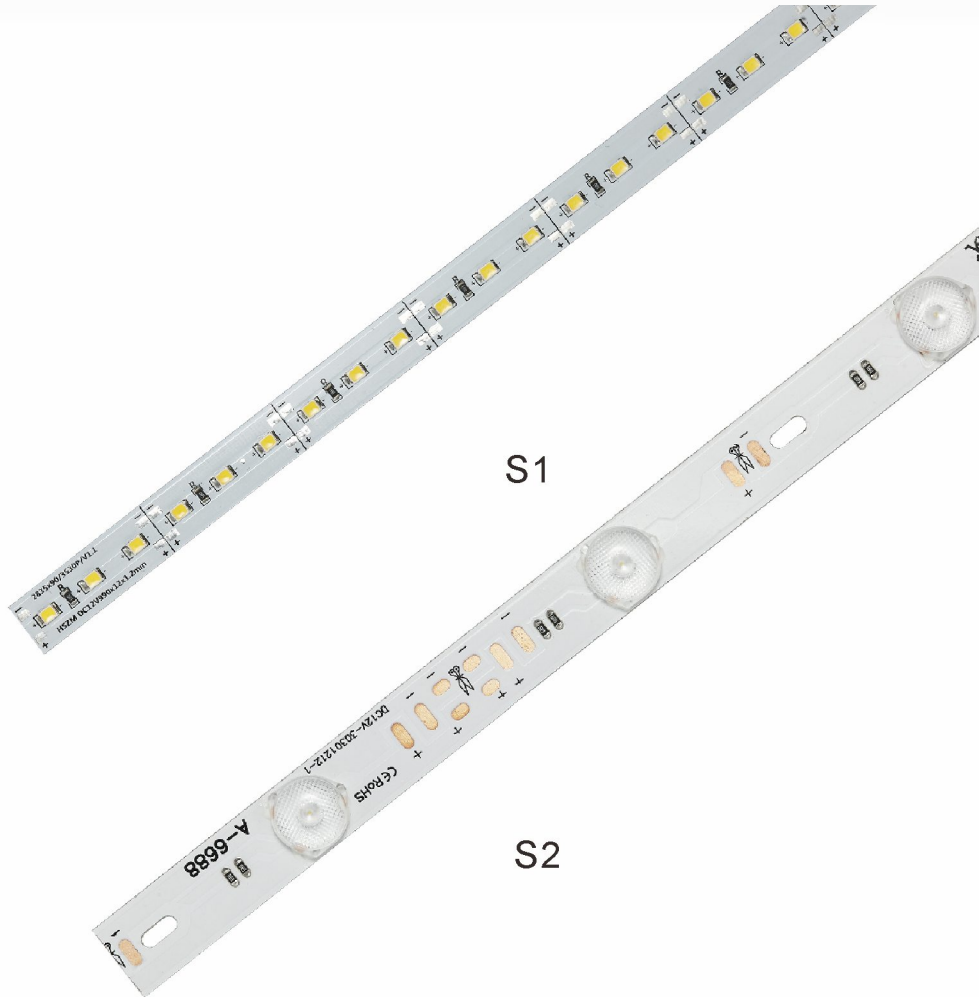

# Tiny Series-A-SMD



Surface mounted LED downlight, can be COB and SMD structure.  
 Power supply 12W/20W/30W/40W/60W  
 Input voltage AC100-277V, on-off/Triac dim/0-10v dim options.  
 Beam angle 70D for SMD type, 15D/24D/36D/60D for COB lens type.  
 Housing color black/white, reflector color black/white/silver/golden.

CCT 2700K/3000K/3500K/4000K/5000K/6000K,  
 CRI90+, fixed type.  
 5 years warranty,  
 Application: villa, residential area, office corridor,  
 hotel, reception room



## Tiny Series-A-SMD-Product Size

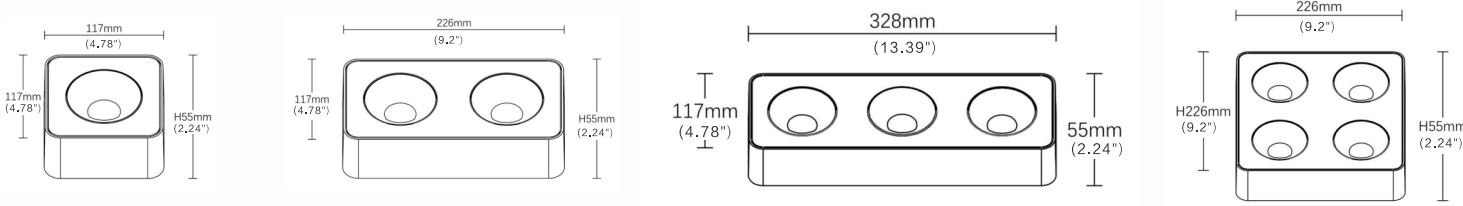

# Tiny Series-B-COB



Item	Specification/Description				
Power Supply	7-12W	20W 2*10W	30W 3*10W	40W 4*10W	60W 6*10W
SMD Dimension	L117*W117*H55mm	L226*W117*H55mm	L328*W117*H55mm	L226*W226*H55mm	
SMD Beam angle	70°	70°	70°	70°	
COB Dimension	L117*W117*H55mm	L226*W117*H55mm	L328*W117*H55mm	L226*W226*H55mm	L398*W248*H55mm
COB Beam angle	15° /24° /36° /60°	15° /24° /36° /60°	15° /24° /36° /60°	15° /24° /36° /60°	15° /24° /36° /60°
Input Voltage	AC100-277V/AC100-348V 60HZ Dimming method: No dim、Triac dim、010V dim、DMX512 dim、DAIL dim				
color	Color: white/black Reflector: black/white/silver/gold/matte black/matte white				

# MASTER D IP65 SERIES



Power supply 15W/20W/30W/40W/50W/60W/90W  
 Input: 100–277V AC, on-off/triac/0–10V/Dali dimming options.  
 Beam angle 20D/40D/60D for round shape, 15D/20D/36D/60D for square shape.  
 Housing color: White/Black. Reflector color: Black, White, Silver  
 CRI90+, UGR<12, No swiveling type

Surface mounted & Pendant installation way available.  
 Ceiling cup standard diameter: 4–3/4” (120mm), make sure the J-box can be contained.  
 Cable standard length: 1m(3.3')(Customized length cables are available)  
 5 years warranty,



## Master D IP65 series-Size

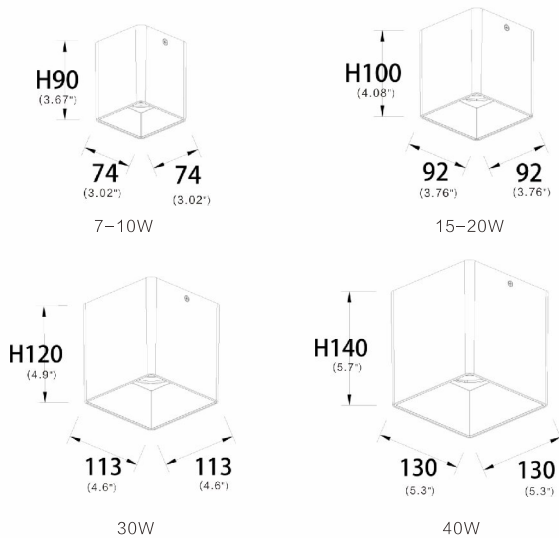

## Application reference

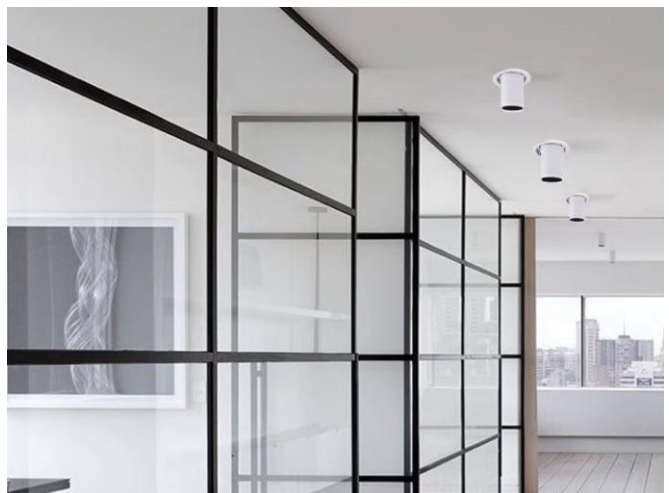

# MASTER D IP65 SERIES

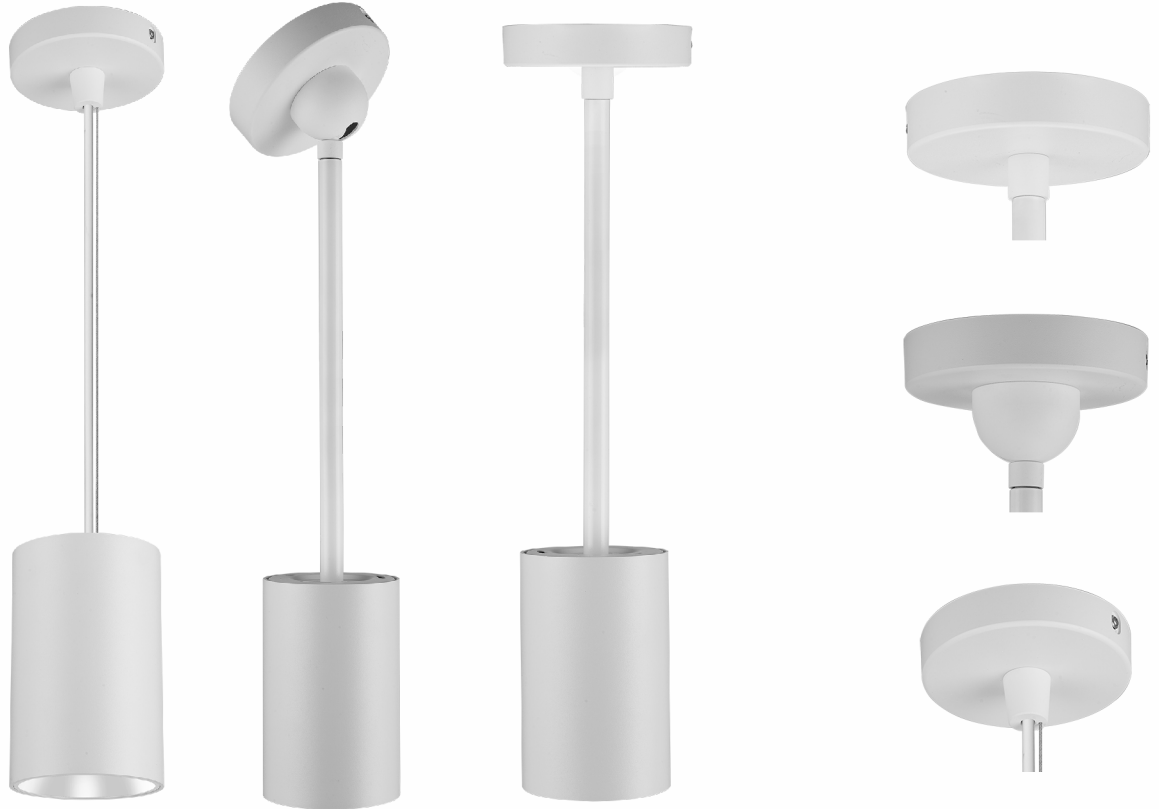

## Master D IP65 series-Size

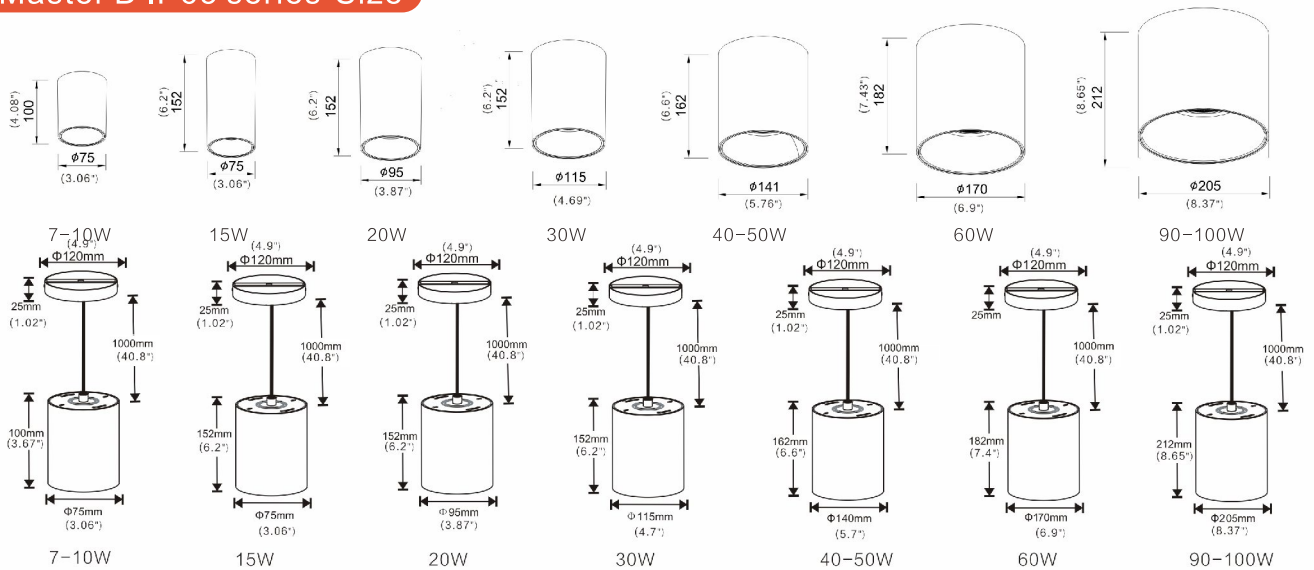

# MASTER B SERIES



Master B Series LED downlight 15W/20W/30W/40W,  
**Input:** 100–277V AC, On–off/triac/0–10V/Dali dimming available,  
 Reflective cup structure.  
 Beam angle 15D/30D/45D, CRI90+, UGR<19  
**Housing color:** White/Black,  
**reflector color:** Black/White/Silver  
 Round & Square, No swiveling type, Surface & Pendant installation.  
**Ceiling cup standard size:** 4–3/4";  
**Cable standard length:** 2ft (customized length cable Available)  
 5 years warranty,



## Master B series-Size

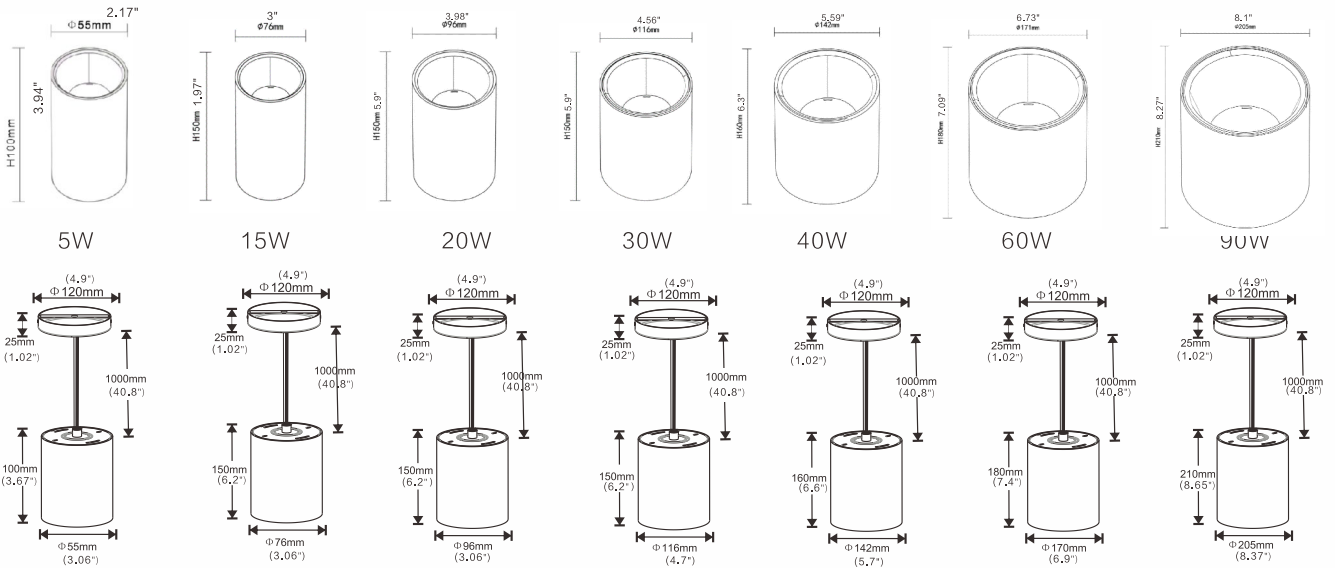



# SQUARE TWO HEADS TYPE

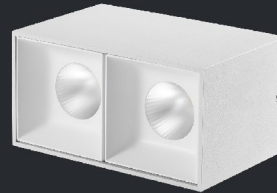
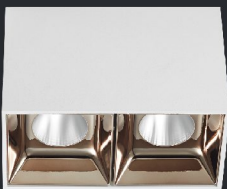

## Square two heads type-Size

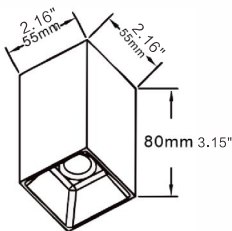

5W

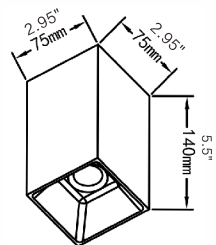

15W

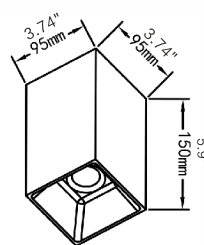

20W

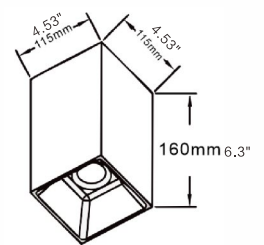

30W

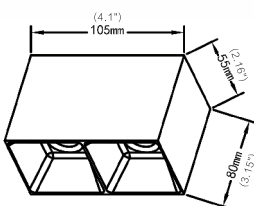

2\*6W ( 12W in total)

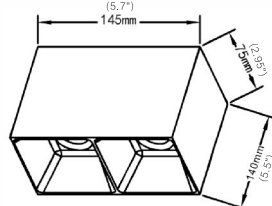

2\*10W (20W in total)

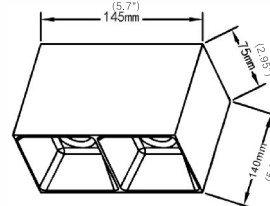

2\*15W (30W in total)

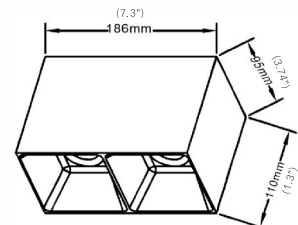

2\*20W (40W in total)

# MASTER W IP65 SEREIS



Wall mounted type LED light, COB lens structure.  
Power supply 15W/20W/30W (with different size).  
Input voltage AC100–277v, on–off/Triac dim/0–10v dim/Dali dim available  
Beam angle 20D/40D, CRI90/CRI97  
Housing color black/white, reflector color black/white/silver/golden option.  
5 years warranty,  
Application: Outdoor wall.





Master w Ip65 sereis -Size

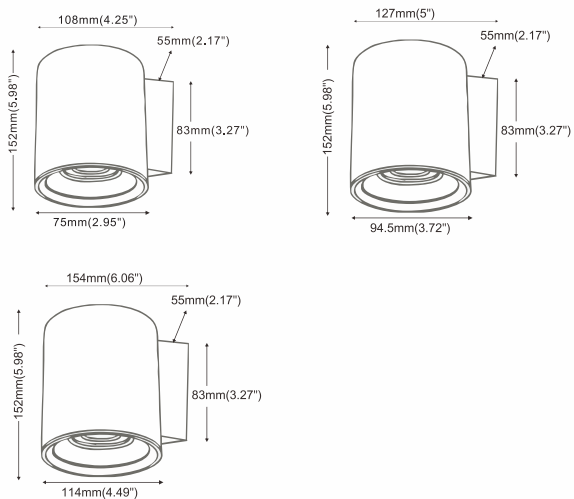

Master w Ip65 sereis -Application

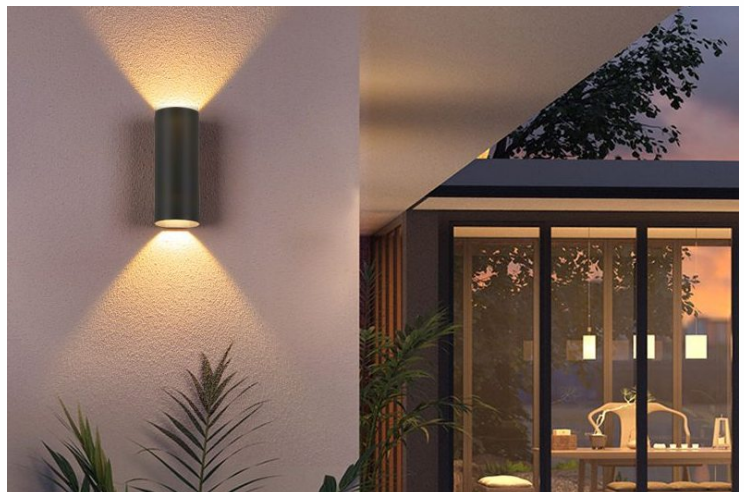

# LED TRACK LIGHT SERIES



High quality products  
Brands chips, CRI90+  
Puer light and clean shadow



# FAMILY(G2) SERIES



1. Family series.
2. 7W, 15W, 20W, 30W, 38W with different sizes.
3. Beam angle: 15D/24D/38D/60D;
4. Color in black or white
5. Options for compatible with Halo, Lightolier or Juno track system. (2 wires/ 3 wires/ 4 wires/ 6wires )
6. Surface mounted type available.



## Family series- Product Size

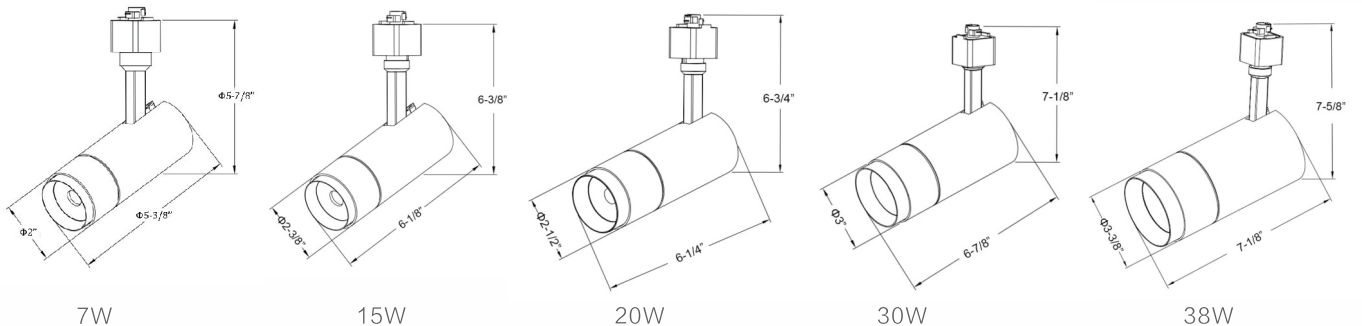

Track system pictures



Halo track system

Juno track system

Local dim



CCT and power adjustable type



Family series surface mounted and recessed mounted optional



surface Mounted type, no need track rail

**Outer size**

Φ 3-3/4 inch (Φ 95mm)

Φ 4-3/4 inch (Φ 120mm)

Φ 5-1/2 inch (Φ 140mm)

Φ 7-1/8 inch (Φ 180)



Recessed mounted type, no need track rail

**Cutout size**

Φ 3 inch (Φ 75mm)

Φ 4 inch (Φ 100mm)

Φ 4-3/4 inch (Φ 120mm)

Φ 5-7/8 inch (Φ 150mm)

# LEICA ZOOM SERIES



- 1. Leica A zoom Series 15W, 20W, 30W
- 2. Beam angle: 15-60° adjustable
- 3. Housing color in Black or White
- 4. Options for compatible with Halo, Juno or Lightolier track system (2 wires/ 3 wires/ 4 wires/ 6wires ).
- 5. Surface mounted type available



Track system pictures

## Product Size and zoom way

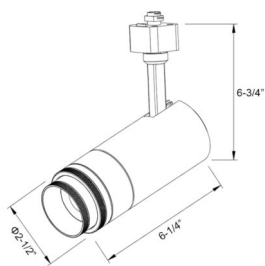

15W/20W

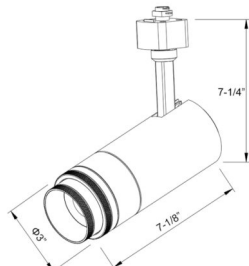

30W

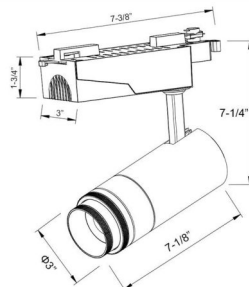

20W/30W





Halo track system



Juno track system



CCT and power adjustable type



Local dim



Zoom Way

Leica zoom series surface mounted & recessed options



surface mounted type, no need track rail



recessed mounted type, no need track rail

**Outer size**

Φ3-3/4 inch(Φ95mm)

Φ4-3/4 inch(Φ120mm)

Φ5-1/2 inch(Φ140mm)

Φ7-1/8 inch(Φ180)

**Cutout size**

Φ3 inch(Φ75mm)

Φ4 inch(Φ100mm)

Φ4-3/4inch (Φ120mm)

Φ5-7/8 inch(Φ150mm)

# ELEGANT SERIES



1. Elegant series,30W.
2. Beam angle: 15D/24D/36D/60D;
3. Color in Black or White
4. Options for compatible with Halo or Lightolier track system (2 wires/ 3 wires/4 wires/ 6wires ).
5. Looks small and elegant, more suitable for ladies & kids' clothes shops



Local dim

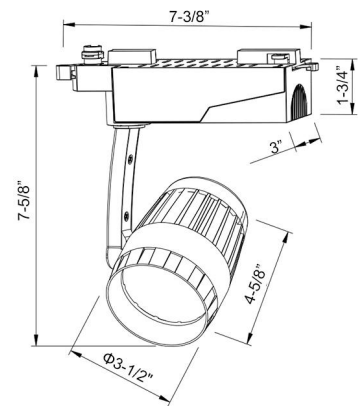

30W

# MUSEUM A SERIES



1. Museum series 20W, 30W
2. Beam: from narrow to wide,  
from round to square and other shapes.
3. Function available: On/Off, Triac dim, Local dim
4. Housing color in Black or white
5. Compatible with Halo or Lightolier track system (2 wires/ 3 wires/4 wires/ 6wires )



Local dim

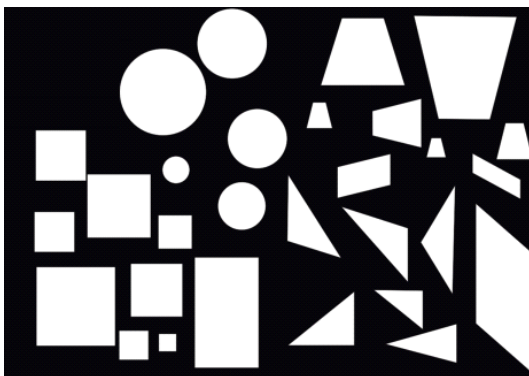

## Museum A series—Product Size

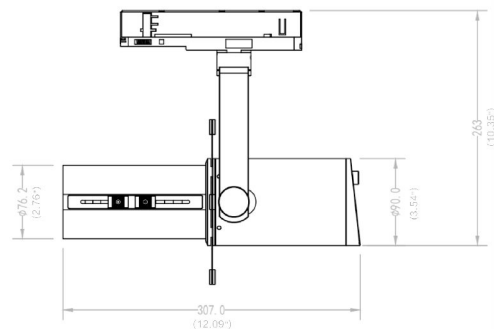

20W/30W

# MUSEUM B SERIES



- 1. Museum series 10W, 15W, 20W, 30W, 35W
- 2. Beam: from narrow to wide, from round to square and other shapes.
- 3. Function available: On/Off, Triac dim

- 4. Housing color in Black
- 5. Compatible with Halo track system  
(2 wires/ 3 wires/4 wires/ 6wires ),  
recessed mounted and surface mounted options



## Museum B series-Product Size

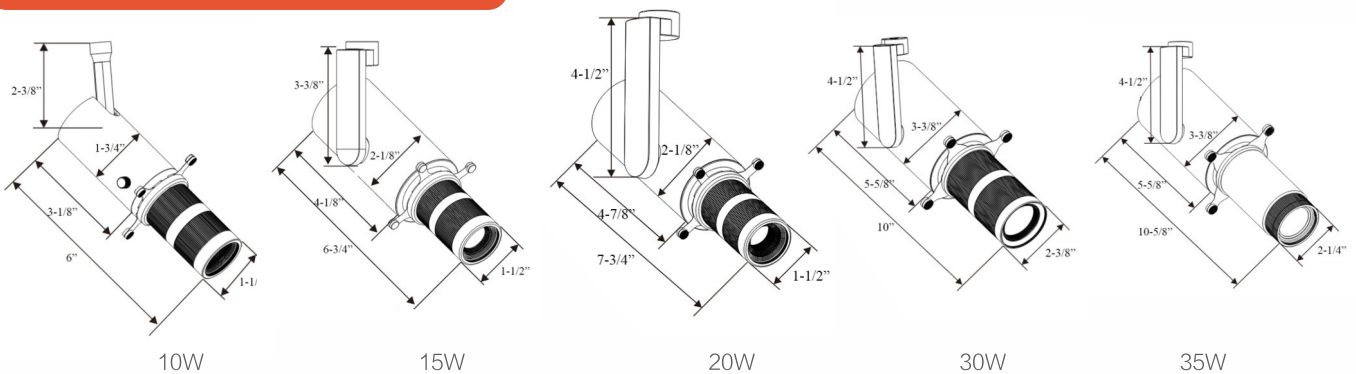

# MUSEUM C SERISE



UK  
CA

CE

RoHS



1. Museum C Series 10W

2. Beam angle: 20-40° adjustable

3. Housing color in Black or White

4. Options for compatible with Halo,

Juno or Lightolier track system (2 wires/ 3 wires/ 4 wires )

5. Surface mounted type available.



## Product Size

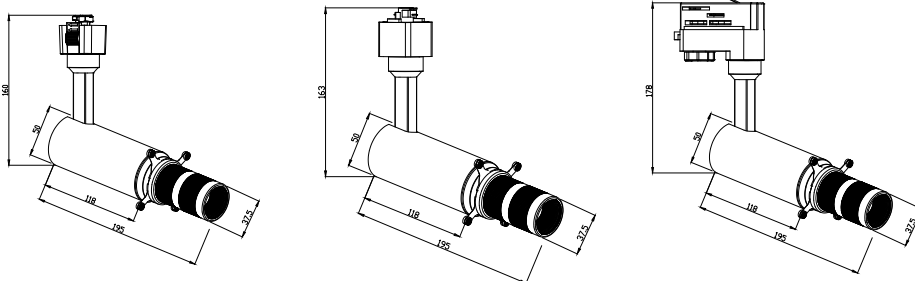

# MUSEUM D SERISE



1. Museum D Series 15W,20W,30W,38W

2. Beam angle:20-40° adjustable

3. Housing color in Black or White

4. Options for compatible with Halo,

Juno or Lightolier track system(2 wires/ 3 wires/4 wires )

5. Surface mounted type available.



## Product Size

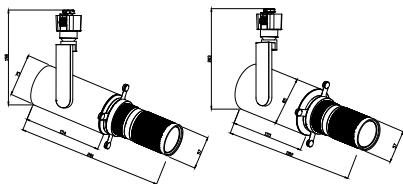

75

85

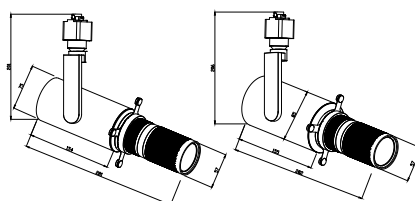

75

85

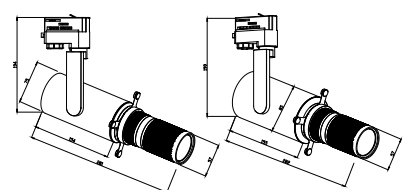

75

85

# LEICA ZOOM S SERIES



- 1. Leica S zoom Series 15W, 20W, 30W
- 2. Beam angle: 15-60° adjustable
- 3. Housing color in Black or White

- 4. Options for compatible with Halo, Juno or Lightolier track system (2 wires/ 3 wires/ 4 wires)
- 5. Surface mounted type available.
- 6. AC100-277V input, on-off/Triac dim options



## Product Size

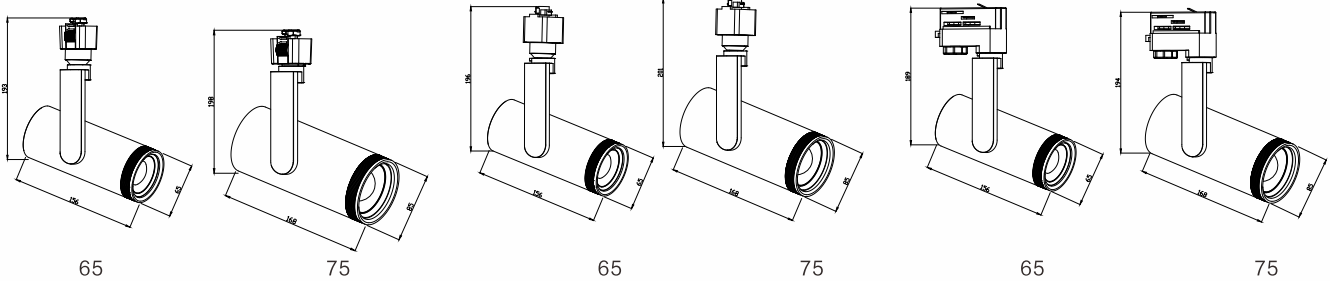

# FAMILY S SERIES



- 1. 7W, 15W,20W, 30W,38W with different sizes.
- 2. Beam angle: 15D/24D/38D/60D;
- 3. Color in black or white
- 4. Options for compatible with Halo, Lightolier or Juno track system(2 wires/ 3 wires/4 wires ).
- 5. Surface mounted type available.
- 6.AC100–277V input,on-off/Triac dim options

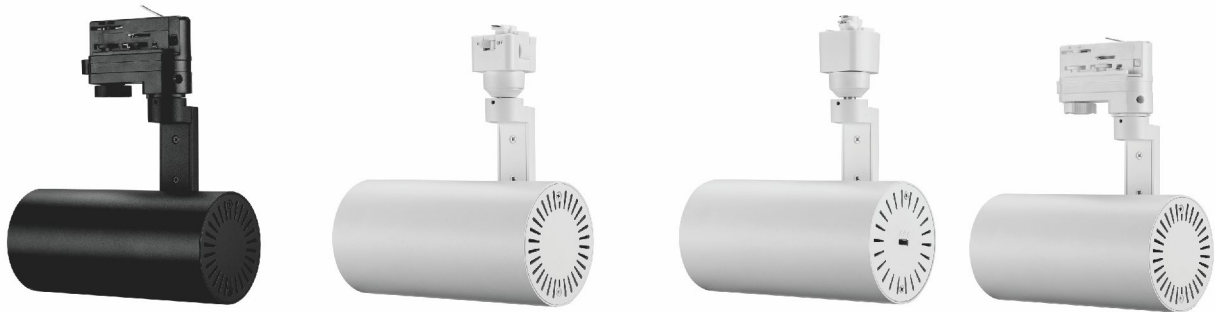

## Product Size

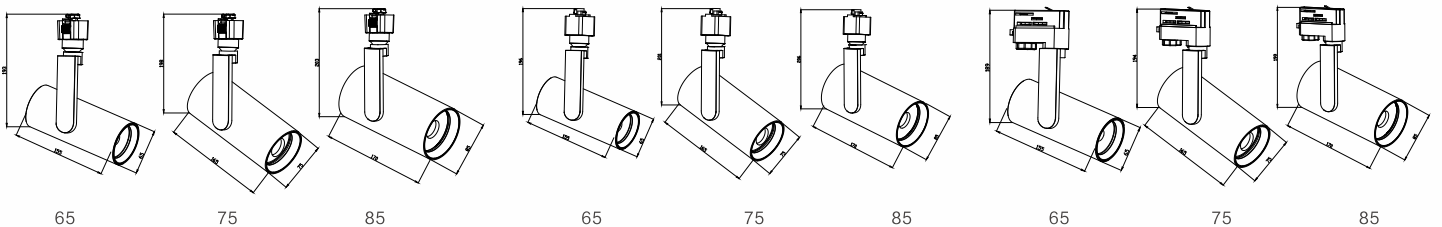



## H-TYPE TRACK RAIL AND ACCESSORIES

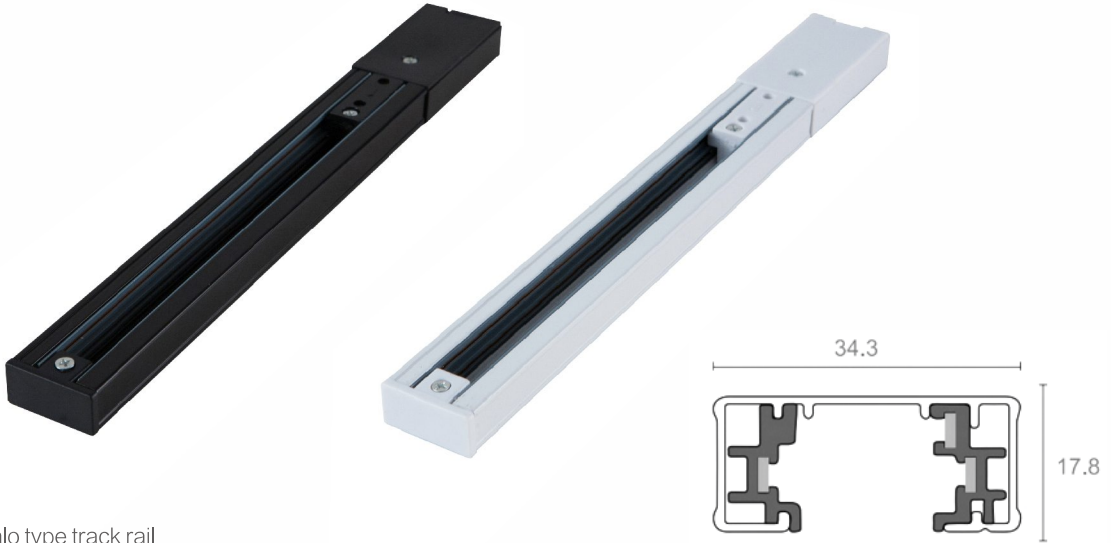

Halo type track rail  
Length: 2ft, 4ft, 6ft, 8ft  
Surface mounted or suspension type



Suspension kit

Halo type Power Feeder and connector

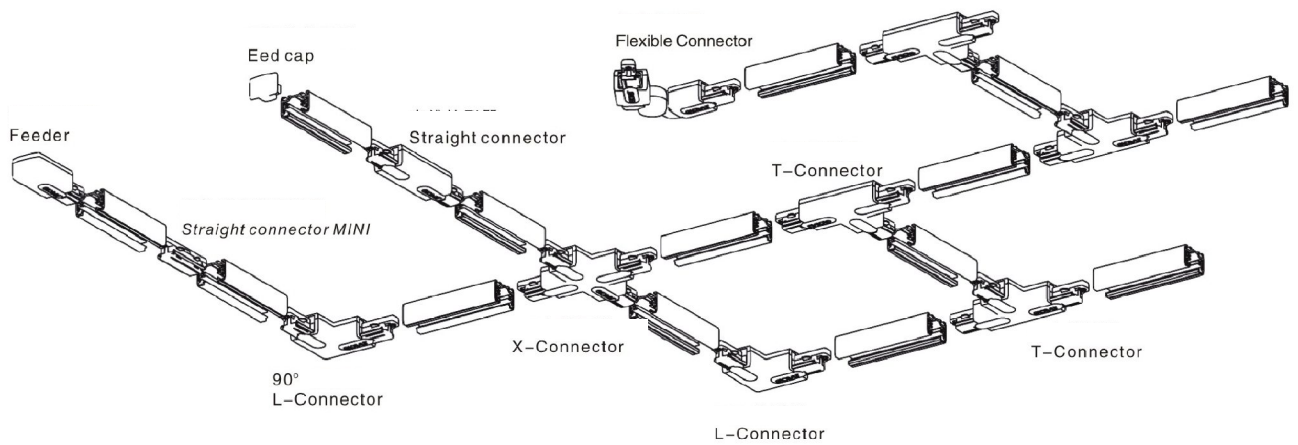

Installation diagram

# MAGNETIC LED TRACK LIGHT



Tip: Cross-match different magnetic lights to make the decoration look more advanced and beautiful.



# FROSTED BASIC SERIES FLOODLIGHT



- 1. Frosted Basic series—floodlight, basic lighting with soft light.
- 2. Power & Size: 12W—L300\*W22\*H45mm,  
20W—L600\*W22\*H45mm, 30W—L900\*W22\*H45mm
- 3. Beam angle: 120°
- 4. Color in black and white

- 5. 48V DC input
- 6. Function options: On-off, 0-10V dim,  
Zigbee Dim (Tuya APP Control), Dali dim,  
Dali dim with CCT change



## Frosted Basic series—floodlight Product Size

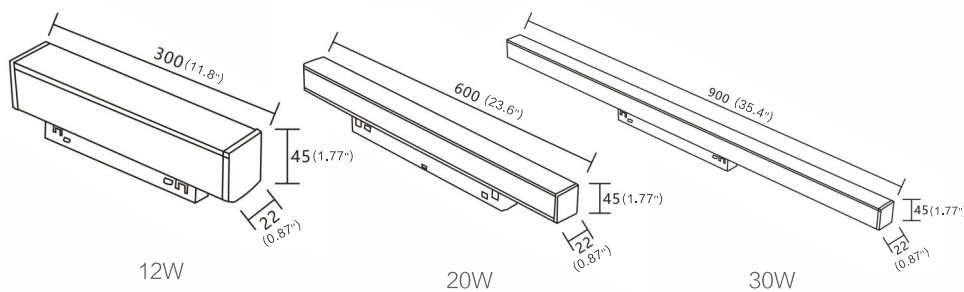

## Frosted Basic series—Application

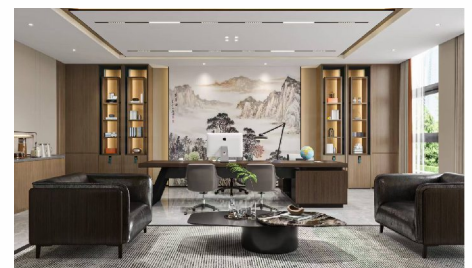

# ANTI-GLARE SERIES GRILLE LIGHT



1. Anti-Glare series-Grille Light, UGR<13.

2. Power & Size: 6W-L122\*W22\*H45mm, 12W-L238\*W22\*H45mm, 18W-L355\*W22\*H45mm

3. Beam angle: 38°

4. Color in black and white, shape in round and square

5. 48V DC input

6. Function options: No-dim, 0-10V dim, Zigbee Dim (Tuya APP Control), Dali dim, Dali dim with CCT change



## Anti-Glare series-Grille Light Product Size

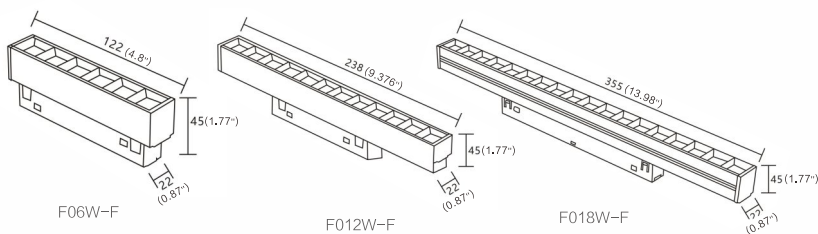

## Anti-Glare series-Application



# ANTI-GLARE SERIES GRILLE LIGHT



1. Anti-Glare series-Grille Light, UGR<13.
2. Power & Size: 6W-L122\*W22\*H45mm, 12W-L238\*W22\*H45mm, 18W-L355\*W22\*H45mm
3. Beam angle: 38°
4. Color in black and white, shape in round and square

5. 48V DC input
6. Function options: No-dim, 0-10V dim, Zigbee Dim (Tuya APP Control), Dali dim, Dali dim with CCT change



## Anti-Glare series-Grille Light Product Size

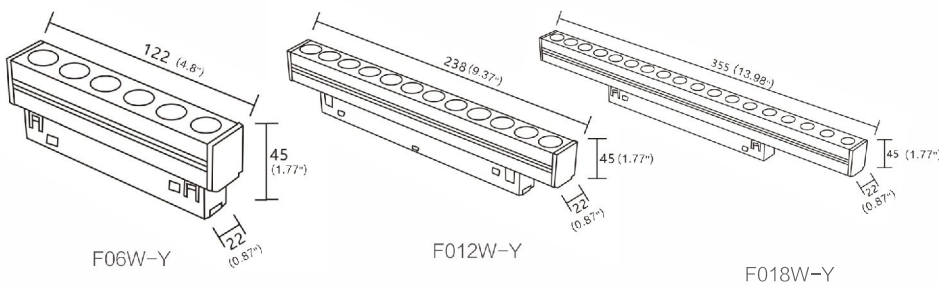

## Anti-Glare series-Application

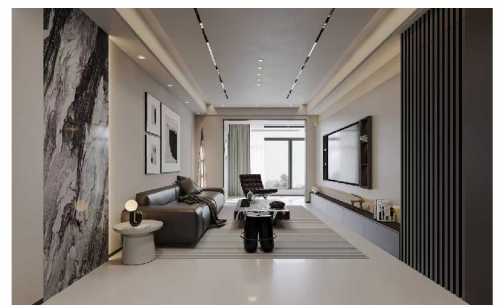

# ANTI-GLARE ROTATED SERIES ADJUSTABLE GRILLE LIGHT



- 1. Anti-glare Rotated Series Grille Light, can be adjusted.
- 2. Power & Size: 6W-L166\*W22\*H83mm, 12W-L286\*W22\*H83mm, 18W-L406\*W22\*H83mm
- 3. Beam angle: 15° /24°
- 4. Color in black and white

- 5. 48V DC input
- 6. Function options: No-dim, 0-10V dim, Zigbee Dim(Tuya APP Control), Dali dim, Dali dim with CCT change



## Application

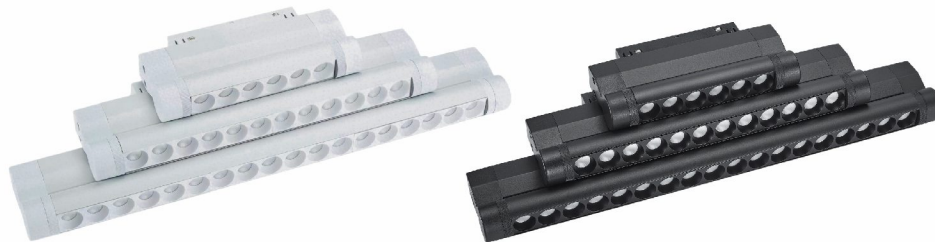
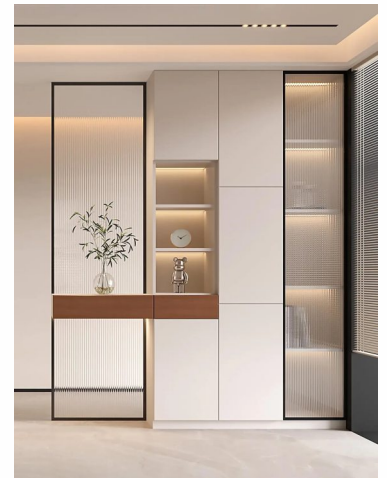

## Anti-Glare Rotated series-floodlight Product Size

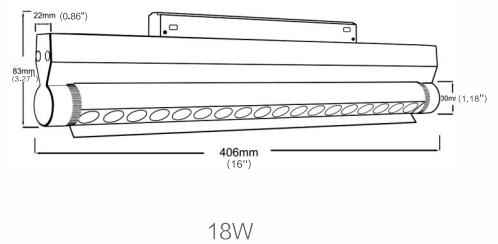
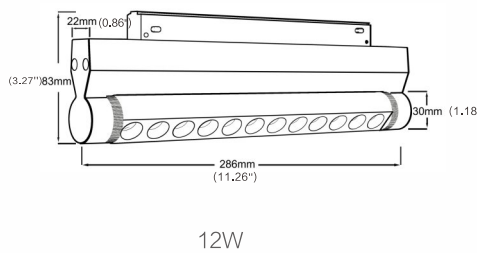
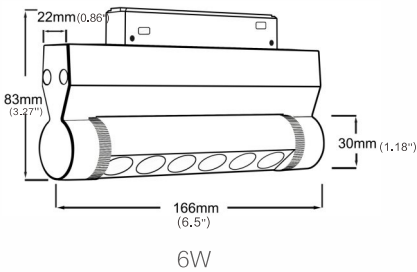

# BOOK SERIES FOLDING GRILLE LIGHT



1. Book series-Folding Grille Light, can be adjusted the lighting direction, UGR<13.

2. Power & Size: 6W-L112\*W22\*H105mm, 12W-L220\*W22\*H100mm, 18W-L332\*W22\*H105mm

3. Beam angle: 15° /24°

4. Color in black and white

5. 48V DC input

6. Function options: No-dim, 0-10V dim, Zigbee Dim (Tuya APP Control), Dali dim, Dali dim with CCT change



## Application

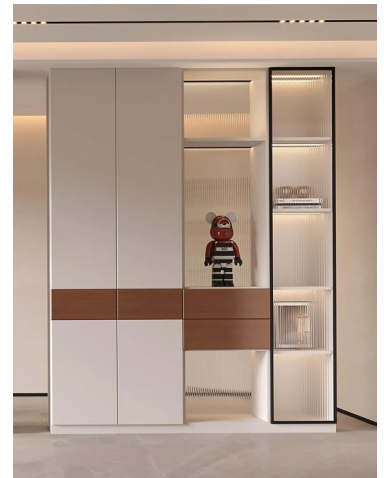

## Book series-Folding Grille Light Product Size

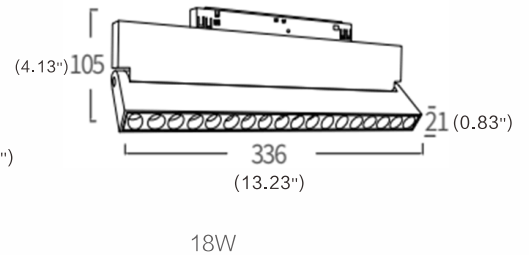
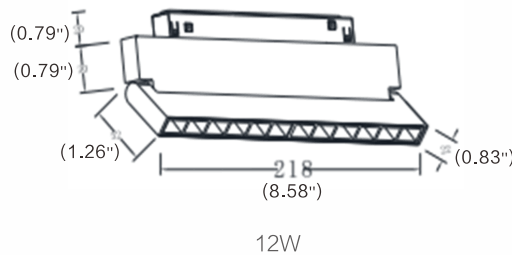
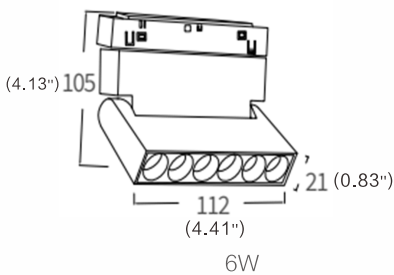

# FROSTED ROTATED SERIES FLOODLIGHT



- 1. Frosted Rotated series—floodlight, can be adjusted.
- 2. Power & Size: 6W—L166\*W22\*H83mm, 12W—L286\*W22\*H83mm, 18W—L406\*W22\*H83mm, 24W—L526\*W22\*H83mm
- 3. Beam angle: 120°
- 4. Color in black and white
- 5. 48V DC input
- 6. Function options: No—dim, 0—10V dim, Zigbee Dim(Tuya APP Control), Dali dim, Dali dim with CCT change



## Application

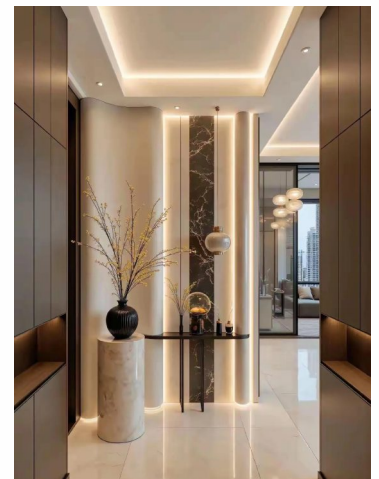

## Frosted Rotated series—floodlight Product Size

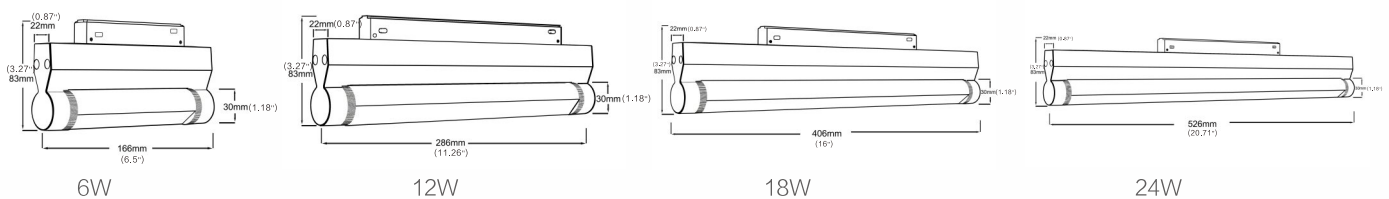

# FROSTED ATMOSPHERE SERIES FLOODLIGHT WITH BAFFLE PLATE



- 1. Frosted Atmosphere Series–Floodlight with baffle plate, can be adjusted.
- 2. Power & Size: 3W–L166\*W22\*H83mm, 5W–L286\*W22\*H83mm, 8W–L406\*W22\*H83mm
- 3. Beam angle: 120°
- 4. Color in black and white
- 5. 48V DC input
- 6. Function options: Zigbee Dim(Tuya APP Control)
- 2.4G RGB+Wdim



## Application reference



## Frosted Atmosphere Series Product Size

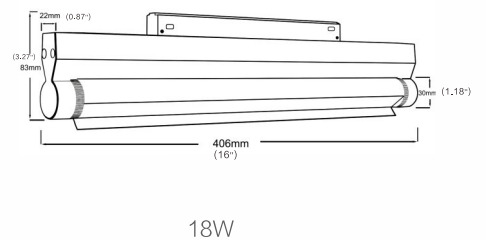
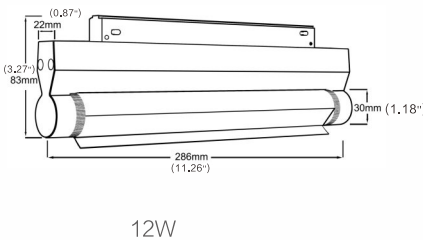
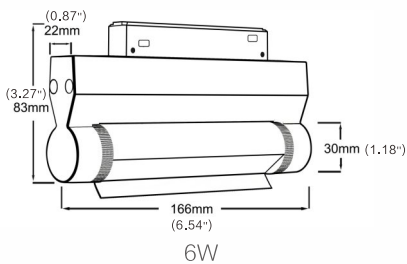

# MAGNETIC PENDANT LIGHT

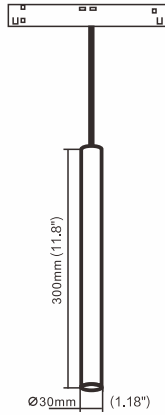

## Slim A Series

Dimension	Φ30*L300mm
Power Supply/Input Voltage	6W/DC48V
CCT	3000-6000K
CRI	Ra ≥ 90
Beam angle	15/24/36

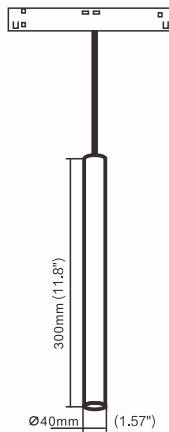

## Slim B Series

Dimension	Φ40*L300mm
Power Supply/Input Voltage	6W/DC48V
CCT	3000-6000K
CRI	Ra ≥ 90
Beam angle	15/24/36

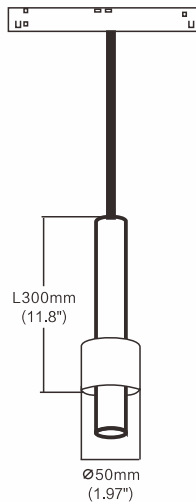

## Slim C Series

Dimension	Φ48*L300mm
Power Supply/Input Voltage	6W/DC48V
CCT	3000-6000K
CRI	Ra ≥ 90
Beam angle	15/24/36

## MASTER SQUARE SERIES

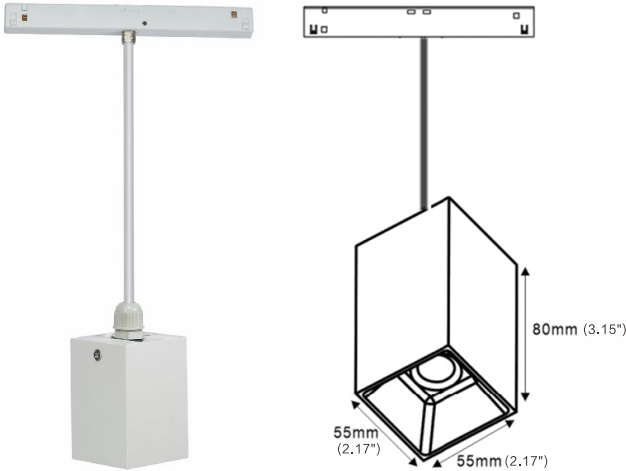

Dimension	W55*L55*H80mm
Power Supply/Input Voltage	6W/DC48V
CCT	3000-6000K
CRI	Ra≥90
Beam angle	15/24/36

## HIP-HOP SERIES(BEAM ANGLE ADJUSTABLE)

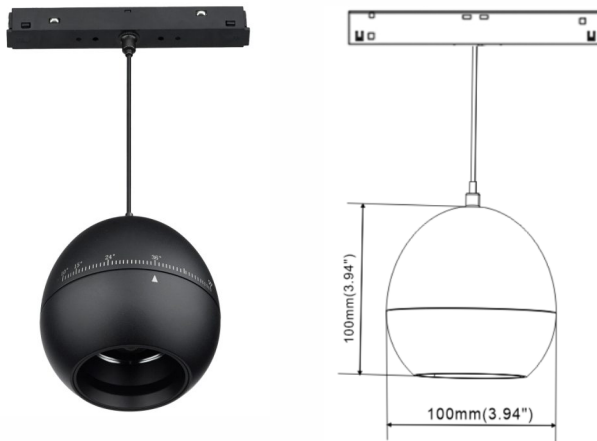

Dimension	Φ 100*L100mm
Power Supply/Input Voltage	12W/DC48V
CCT	3000-6000K
CRI	Ra≥90
Beam angle	15-55D





## CRYSTAL CYLINDRICAL CHANDELIER

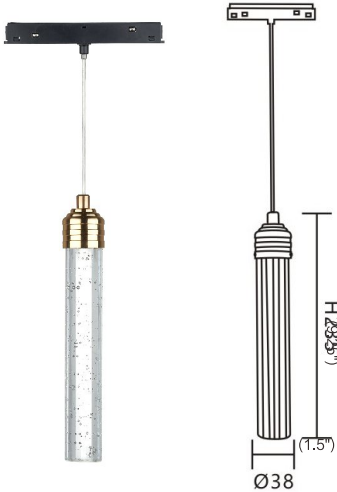

Dimension	Φ 38*L235mm
Power Supply/Input Voltage	3W/DC48V
CCT	3000-6000K
CRI	Ra ≥ 90
Beam angle	150D

## CRYSTAL CORN CHANDELIER



Dimension	Φ 46*L225mm
Power Supply/Input Voltage	3W/DC48V
CCT	3000-6000K
CRI	Ra ≥ 90
Beam angle	150D

## WATER DROP CHANDELIER



Dimension	Φ 50*L315mm
Power Supply/Input Voltage	3W/DC48V
CCT	3000-6000K
CRI	Ra ≥ 90
Beam angle	150D



## RYSTAL SPHERICAL CHANDELIER



Dimension	Φ 59*L336mm
Power Supply/Input Voltage	3W/DC48V
CCT	3000-6000K
CRI	Ra ≥ 90
Beam angle	150D

### Application reference



# LEICA ZOOM M SERIES SPOT LIGHT



1. Leica Zoom M Series—Spot Light, accent light.
2. Power & Size: 15W/20W— $\Phi$ 65mm\*138mm
3. Beam angle: 15° – 60° adjustable
4. Color in black and white
5. 48V DC input
6. Function options: No-dim, 0–10V dim, Zigbee Dim(Tuya APP Control), Dali dim, Dali dim with CCT change

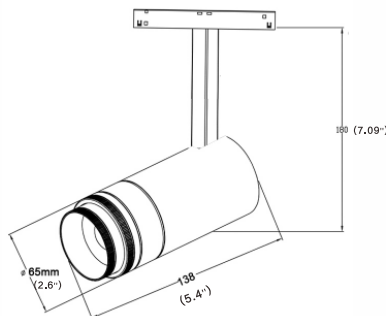

15W-20W

# FAMILY M SERIES SPOT LIGHT



- 1. Family M series spot light, accent light.
- 2. Power & Size: 7W/12W/15W-Φ50mm\*135mm,  
20W-Φ60mm\*157mm, 25W-Φ65mm\*160mm
- 3. Beam angle: 15° /24° /36° /60°
- 4. Color in black and white

- 5. 48V DC input
- 6. Function options: No-dim, 0-10V dim,  
Zigbee Dim(Tuya APP Control), Dali dim,  
Dali dim with CCT change



## Family M Series-Folding Grille Light Product Size

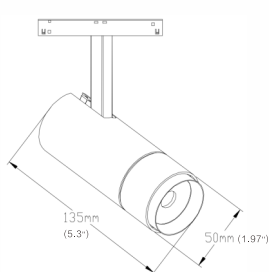

15W

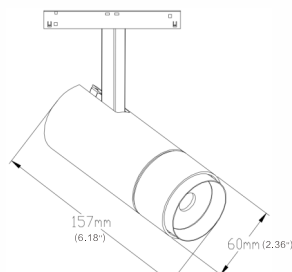

20W

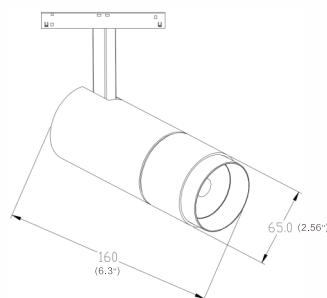

25W

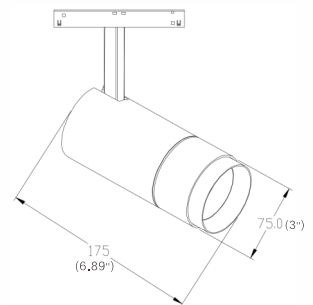

30W



# MUSEUM M SERIES-SPOT LIGHT



- 1.Museum M Series spot light, can be adjusted in different shape.
- 2.Power & Size:10W-Φ38\*L153mm, 10W-Φ38\*L157mm
- 3.Beam angle: 18-36D, from narrow to wide, from round to square and other shapes.
- 4.Color in black and white

- 5.48V DC input
- 6Function options: No-dim, 0-10V dim, Zigbee Dim(Tuya APP Control), Dali dim, Dali dim with CCT change



## Museum M Product Size

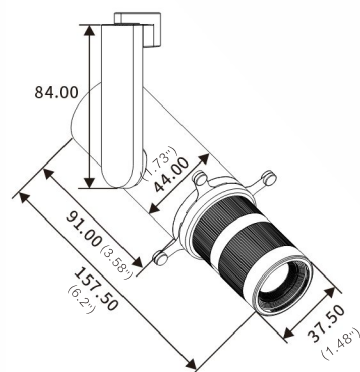
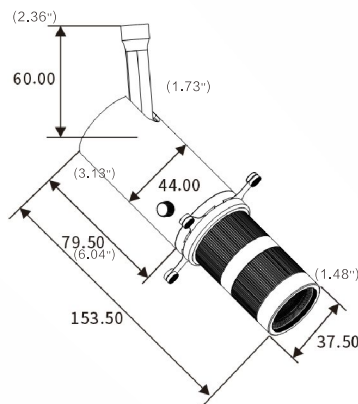



# INTERNAL DRIVER(INTEGRATED TRANSFER)



Production No.	size	power parameters	voltage and current
DT-D22A48V-2500	L443*W22*H45mm	150W/DC48V	voltage input: AC100-277V voltage output: DC48V current output: 3A Dimming function: NO
DT-D22AB48V-2500	L443*W22*H45mm	150W/DC48V	voltage input: AC100-277V voltage output: DC48V current output: 3A Dimming function: 0-10VDIM
DT-D22A48V-2500	L443*W22*H45mm	200W/DC48V	voltage input: AC100-277V voltage output: DC48V current output: 4.1A Dimming function: NO
DT-D22A48V-2500	L443*W22*H45mm	200W/DC48V	voltage input: AC100-277V voltage output: DC48V current output: 4.1A Dimming function: 0-10VDIM



# MAGNETIC TRACK RAIL, POWER SUPPLY AND ACCESSORIES

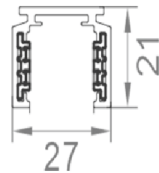

Name	Mounting Type	Material	Colour	Length
DT-20M27A	Surface mounted	aluminum	black/white	1M/2M/3M



L-shape corner

Name	Mounting Type	Material	Colour	Length
20M27A-20LM	Surface mounted	aluminum	black/white	PCS



corner  
Vertical Angle

Name	Mounting Type	Material	Colour	Length
20M27A-20FM	Surface mounted	aluminum	black/white	PCS

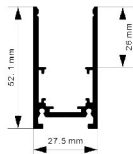

Name	Mounting Type	Material	Colour	Length
DT-20M27H	pendant mounted	aluminum	black/white	1M/2M/3M

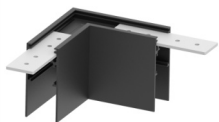

L-shape corner

Name	Mounting Type	Material	Colour	Length
20M27H-20LM	pendant mounted	aluminum	black/white	PCS

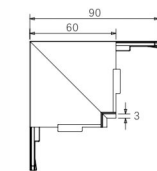

Corner vertical angle

Name	Mounting Type	Material	Colour	Length
20M27H-20FM	pendant mounted	aluminum	black/white	PCS



T-shape corner

Name	Mounting Type	Material	Colour	Length
20M27H-20TM	pendant mounted	aluminum	black/white	PCS



x-shape corner

Name	Mounting Type	Material	Colour	Length
20M27H-20JM	pendant mounted	aluminum	black/white	PCS

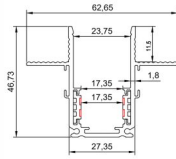

Name	Mounting Type	Material	Colour	Length
DT-20M60M	Recessed mounted 11mm Slot size 34mm	aluminum	black/white	1M/2M/3M

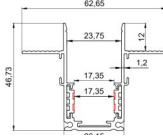

DT-20M60M	Recessed mounted 12mm Slot size 34mm	aluminum	black/white	1M/2M/3M
-----------	-----------------------------------------	----------	-------------	----------



DT-20M60M	Recessed mounted 13mm Slot size 34mm	aluminum	black/white	1M/2M/3M
-----------	-----------------------------------------	----------	-------------	----------

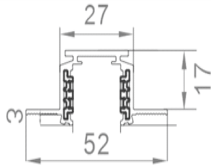
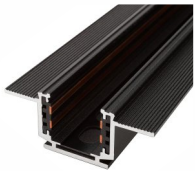

Name	Mounting Type	Material	Colour	Length
DT-20M27B	Recessed mounted 2mm Slot size 29mm	aluminum	black/white	1M/2M/3M

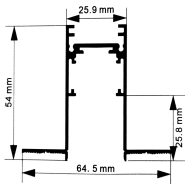

Name	Mounting Type	Material	Colour	Length
DT-20M50M	Recessed mounted 2mm Slot size 27mm	aluminum	black/white	1M/2M/3M

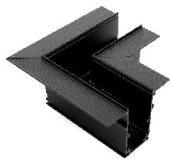

L-shape corner

Name	Mounting Type	Material	Colour	Length
20M50M-20LM	Recessed mounted	aluminum	black/white	PCS

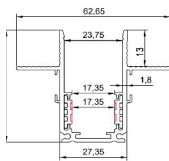

Name	Mounting Type	Material	Colour	Length
20M60M-20LWY	Rscessed mounted	aluminum	black/white	PCS



T-type corner

Name	Mounting Type	Material	Colour	Length
20M60M-20FWY	Rscessed mounted	aluminum	black/white	PCS



X-shape corner

Name	Mounting Type	Material	Colour	Length
20M60M-20TWY	Rscessed mounted	aluminum	black/white	PCS

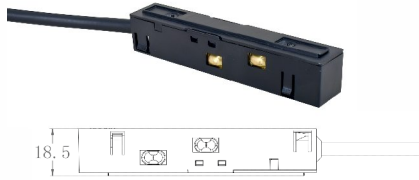

Name	Mounting Type	Material	Colour	size
20-4-XD	Power feeder	/	black/white	L95*W17*H17mm



Name	Mounting Type	Material	Colour	size
20-4-XY	straight connector	/	black/white	L195.9*W16*H18.7mm



Name	Mounting Type	Material	Colour	size
20-4-XW	universal connector 4 wire	/	black/white	L95*W17*H17mm wire length 380mm



Name	Mounting Type	Material	Colour	size
20-4-XW	universal connector 4 wire	/	black/white	L95*W17*H17mm wire length 20mm



Name	Mounting Type	Material	Colour	size
20-4-TW	T-shape connector	/	black/white	L95*W17*H17mm



Name	Mounting Type	Material	Colour	size
20-4-JW	X-shape connector	/	black/white	L95*W17*H17mm

# THE COMPOSITION OF A SET OF LAMPS

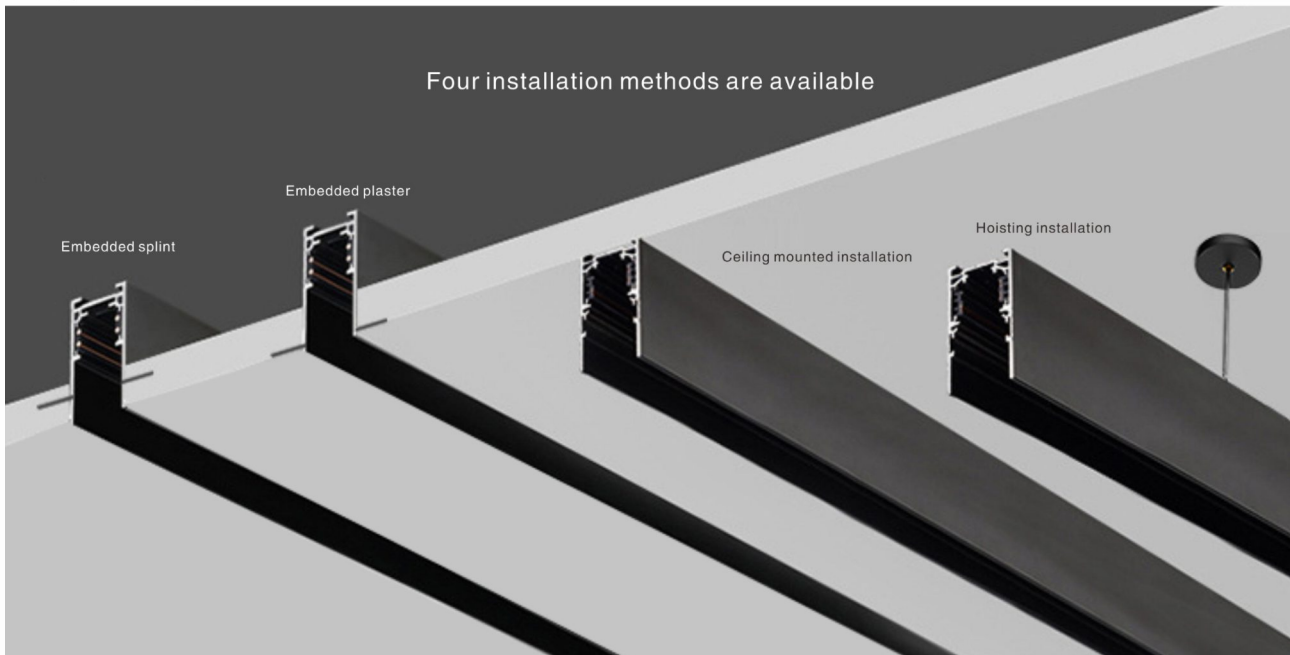
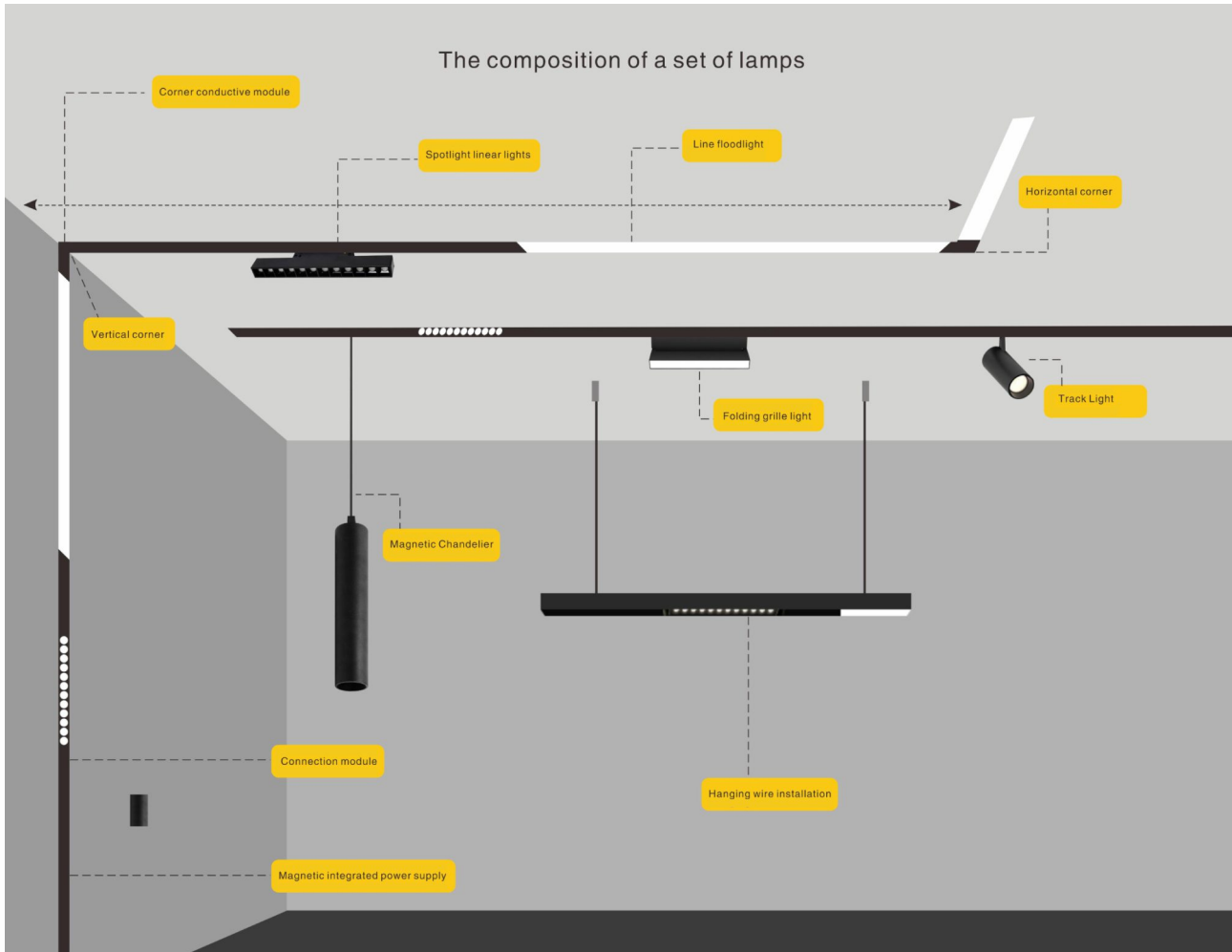



**20 Models schematic diagram of embedded splint installation**

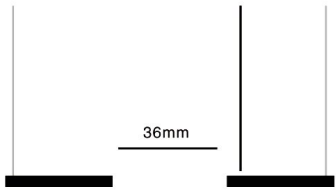

Ceiling slot width 36mm depth 50mm

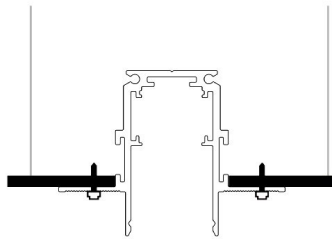

Place the track into the slot and lock the track to the ceiling with M4 tapping screws

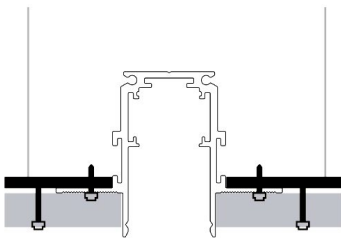

Install the gypsum board on the track and block the wings of the track

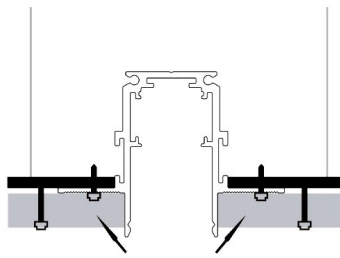

Surface ash

**20 Models schematic diagram of embedded batch ash installation**

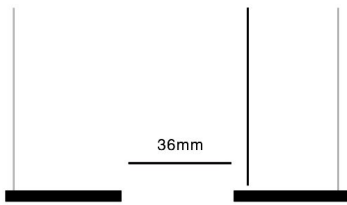

Ceiling slot width 36mm depth 50mm

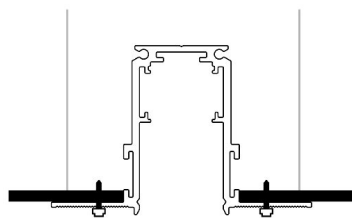

Place the track into the slot and lock the track to the ceiling with M4 tapping screws

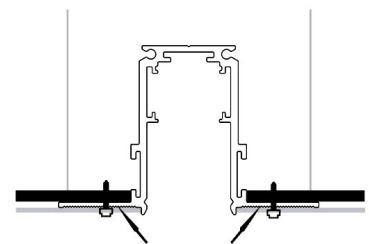

Batch the track surface with ash, covering the exposed wing as shown

**20 Models surface mounting/hoisting installation diagram**

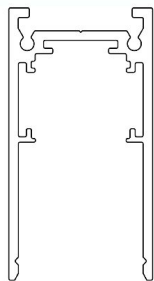

Ceiling type, using screws to fix the track on the ceiling

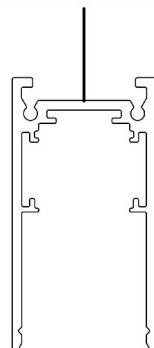

Use the accessories in the lifting bag to lift the track